

Level 1B HMA Roadway Specialist

TABLE OF CONTENTS

1. Rights and Responsibilities
2. Website
3. Tex-207-F Determining Density of Compacted Bituminous Mixtures (Parts 3, 4, 5 & 7)
4. Tex-222-F Sampling Bituminous Mixtures
5. Tex-225-F Random Selection of Bituminous Mixture Samples (Part 2)
6. Tex-244-F Thermal Profile of Hot Mix Asphalt
7. Tex-246-F Permeability of Water Flow of Hot Mix Asphalt
8. Tex-251-F Obtaining and Trimming Core of Bituminous Mixtures
9. Tex-500-C Sampling Bituminous Mixtures, Pre-Molded Joint Fillers, and Joint Sealers (Parts 1, 2, 3 & 9)
10. SS3077 Superpave Mixtures

©2020 HMAAC - All Rights Reserved

No part of this publication may be reproduced, stored in a retrieval system or transmitted in any form or by any means, mechanical, electronic, photocopying, recording or otherwise without the prior written permission of the Texas Asphalt Pavement Association



HMAC CERTIFIED SPECIALIST & APPLICANTS FOR CERTIFICATION: RIGHTS AND RESPONSIBILITIES

This agreement (the "Agreement") affirms that, _____, the below Applicant for Certification or the current Certified Specialist (collectively, the "Specialist") seeks to meet or has successfully met the requirements for certification by the Texas Asphalt Pavement Association ("TXAPA"), a/k/a the Hot Mix Asphalt Center (HMAC) as a certified technician. In that connection, the Specialist agrees as follows:

RIGHTS AND RESPONSIBILITIES - HMAC certification includes the exclusive right to perform certified sampling, testing and reporting on Texas Department of Transportation (TxDOT) projects involving Hot Mix Asphalt (HMA) and Soils & Base (SB) in accordance with TxDOT specifications and test procedures (as may be amended by TxDOT from time to time) for the level of certification issued. Specialists are required to perform and report test results with the accuracy and precision required of a certificated HMA or SB Specialist. It is important that the Specialist fully understands the significance of performing these duties in accordance with the certification level received by the Specialist.

Each Specialist is responsible for performing their own independent sampling, testing and reporting in accordance with TxDOT specifications, test procedures and standard operating procedures. These duties must be performed in a diligent and professional manner to produce TxDOT projects of the highest possible quality.

CONTACT INFORMATION - It is the Specialist's responsibility to provide the HMAC with current contact information by logging into www.txhmac.org. Communications from the HMAC will primarily be sent electronically to the most recent contact information provided by the Specialist.

ANNUAL PROFICIENCY - Once certified, Specialists are required to complete annual proficiency testing and the reporting of results to the HMAC. The testing and reporting must be timely and independently performed by the Specialist and, where applicable, in conformance with the requirements of the Specialist's certifications. TxDOT will ship the annual proficiency samples to the Specialist's address of record. (If this address is not current, the Specialist may not timely receive a proficiency sample and his/her certification may be danger of lapsing.)

Failure to submit proficiency test results or to respond to low rating(s) by the appointed deadlines may result in a change of certification status from active to inactive. Specialists whose certifications are inactivated because their annual proficiency testing/reporting is not current or whose certifications have been revoked or inactivated are prohibited from performing the duties associated with all certifications held by that Specialist.

RECERTIFICATION - Certification(s) are valid for three (3) years from the date originally issued, after which the Specialist must be recertified by again passing the requirements for certification. Specialists may seek recertification up to one year prior to the expiration of their certificate(s).

Failure to timely obtain recertification will cause all dependent certifications held by a Specialist to be inactivated. It is the Specialist's responsibility to maintain an active certification(s). (The HMAC will not provide reminders of pending expiration dates.)

ALLEGATIONS OF MISCONDUCT - Allegations of misconduct should be submitted to the HMAC, P.O. Box 149, Buda, TX 78610 and must include the name, address and signature of the individual asserting the allegations as well as a brief description of the allegations.

If the allegations are properly submitted and appear to have merit, the HMAC Steering Committee (the "Committee") the individual asserting misfeasance and the person so accused will be asked to meet in person (but at separate dates/times) with members of the Committee. At the conclusion of the meeting(s), the Committee will issue its determination.

Misconduct generally consists of (i) neglect, (ii) abuse and/or (iii) breach of trust which are generally defined as:

1. Neglect: unintentional deviation(s) from specifications or testing procedures;
2. Abuse: careless or deliberate deviation from specifications or testing procedures; and
3. Breach of Trust: violation of the trust placed in Certified Specialists including, but not limited to, acts such as:
 - a. Falsification of or deliberate omission from material records or information; or
 - b. Awareness of improprieties in sampling, testing and/or production by others and the failure to timely report those improprieties to the appropriate project supervision.

The Committee may issue written reprimands (private or public) and/or revoke or inactivate a certification (if the Specialist has made a false representation or misstatement to the Committee or to the public or has engaged in misconduct) or take such other actions as the Committee, in its sole discretion, determines to be appropriate with respect to the Specialist's certification(s).

Specialists who do not achieve recertification or whose certification is revoked or inactivated by the Committee may appeal to a separate appeals committee comprised of industry members (the "Appeal Committee"). The exhaustion of this right of appeal to the Appeal Committee is a prerequisite to the exclusive remedy of administrative review by final and binding arbitration in Hays County, Texas, as administered by the American Arbitration Association by a single-member panel. Any and all other claims related in any way to this Agreement are exclusively subject to final and binding arbitration in Hays County, Texas as administered by the American Arbitration Association by a single-member panel.

In consideration for the HMAC certification/recertification process, Specialist hereby waives any and all claims of whatsoever kind or character related, directly or indirectly, to this Agreement, against the TXAPA, HMAC (including, but not limited to, the Committee and the Appeal Committee and their members), that s/he may have (including claims for attorney's fees) and further agrees to save, indemnify and hold TXAPA, the HMAC (including, but not limited to, the Committee and the Appeal Committee and their members) harmless from any claim, action or cause of action arising as a result of, or relating to this Agreement including, but not limited to, Specialist's certification, or any refusal, reprimand, revocation and/or suspension of certification or recertification of Specialist.

ACKNOWLEDGED & AGREED:

SPECIALIST:

SIGNATURE

DATE

PRINTED NAME

WEBSITE

www.txhmac.org

**IT IS YOUR
RESPONSIBILITY
TO KEEP YOUR
INFORMATION
UP TO DATE**

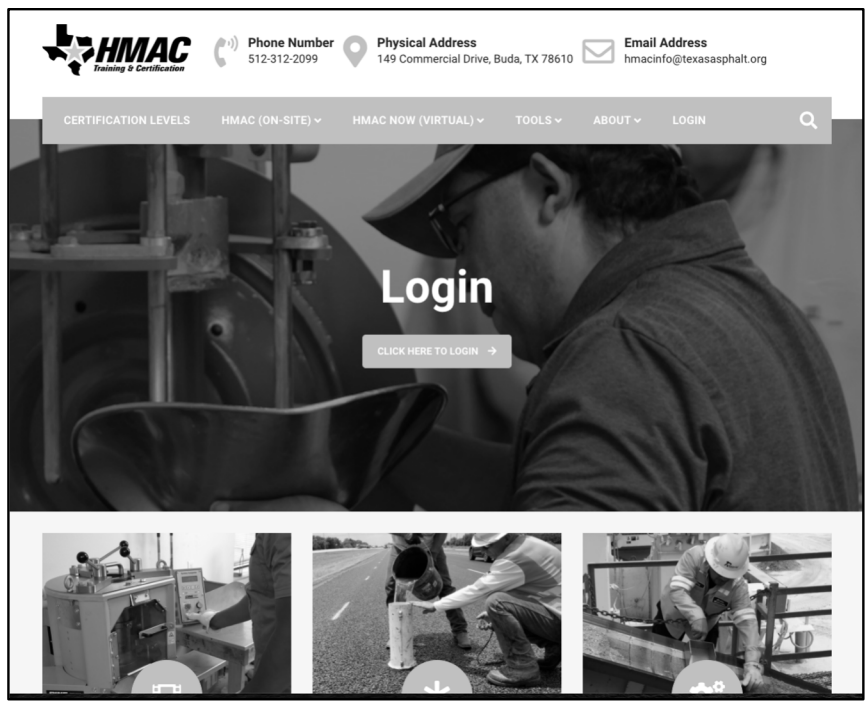

FIRST TIME LOGIN

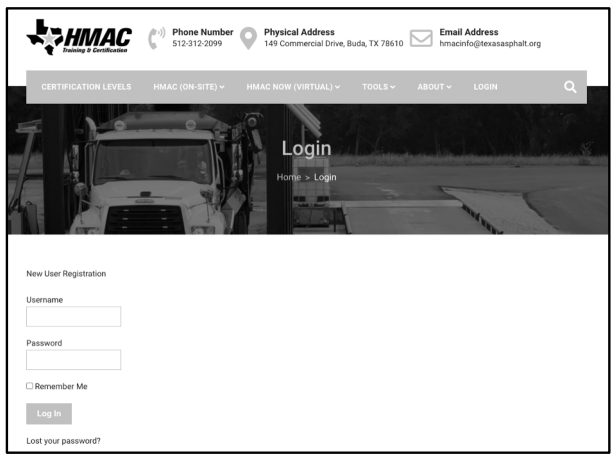

- Username: Capitalize the **FIRST LETTER OF YOUR FIRST AND LAST NAME** then spell out the rest of your last name in lower case, followed by the last 4 digits of your SSN.
- Password: The same but add a "+" at the end.

Example: John Doe
Username: **JDoe1234**
Password: **JDoe1234+**

UPDATE INFORMATION

The screenshot shows the HMAC user registration form. At the top, there is a navigation bar with the HMAC logo and contact information: Phone Number (512-312-2099), Physical Address (149 Commercial Drive, Bufta, TX 78610), and Email Address (hmacinfo@texasasphalt.org). Below the navigation bar is a search bar and a menu with options: CERTIFICATION LEVELS, HMAC (ON-SITE), HMAC NOW (VIRTUAL), TOOLS, ABOUT, and MY ACCOUNT. The main content area features a 'Login' button and a 'Contact Info' section. The 'Contact Info' section includes fields for Username (jdoe1234), E-mail (jdoe@gmail.com), Work Email (jdoe@texasasphalt.org), First Name (John), Last Name (Doe), Company (HMAC), Company Type (Lab / Other), Last 4 digits of SSN (1234), and Call Phone ((512) 312-2099). There is also a 'Password' section with a 'Change Password' link and a note: 'To change password, enter new password here. (Leave it blank if not changing.)'. Below this, there are two input fields for the new password and a note: 'Type your new password again. Password must be at least 8 characters and must contain at least one lower case letter, one upper case letter, one digit, and one symbol.' A 'Next' button is located at the bottom left of the form.

- Verify that all information is correct.

UPDATE INFORMATION

VIEW/PRINT CERTIFICATIONS

PROFICIENCY

The screenshot shows the HMAC user dashboard. At the top, there is a navigation bar with the HMAC logo and contact information: Phone Number (512-312-2099), Physical Address (149 Commercial Drive, Bufta, TX 78610), and Email Address (hmacinfo@texasasphalt.org). Below the navigation bar is a search bar and a menu with options: CERTIFICATION LEVELS, HMAC (ON-SITE), HMAC NOW (VIRTUAL), TOOLS, ABOUT, and MY ACCOUNT. The main content area features a 'Login' button and a 'Certification' section. The 'Certification' section includes a table with columns: Cert Name, Cert Date, Cert Num, Expiration Date, and Status. Below the table are two buttons: 'Proficiency Instructions' and 'Annual Proficiency Reports'. The 'Sofix Class' section includes a table with columns: Cert Name, Cert Date, Cert Num, Expiration Date, and Status. Below the table is a note: 'Prerequisite: SB201 is required.' and two buttons: 'Proficiency Instructions' and 'Annual Proficiency Reports'. At the bottom left, there are buttons for 'Back', 'Log out', and 'Edit'.

Cert Name	Cert Date	Cert Num	Expiration Date	Status
1A	07/27/2018	3082	07/27/2021	Active
1B	01/27/2018	2723	01/27/2021	Active
2	02/06/2015	647	02/06/2018	Active
AGG101	08/30/2018	0005	08/30/2021	Active

Cert Name	Cert Date	Cert Num	Expiration Date	Status
SB101	02/23/2006	002	02/23/2009	Inactive
SB102	02/23/2006	45	02/23/2009	Inactive
SB103				
SB201				
SB202				

Test Procedure for

DETERMINING DENSITY OF COMPACTED BITUMINOUS MIXTURES



TxDOT Designation: Tex-207-F

Effective Date: **January 2020**

1. SCOPE

- 1.1 This test method determines the bulk specific gravity (G_a) of compacted bituminous mixture specimens. Use the G_a of the specimens to calculate the degree of densification or percent compaction of the bituminous mixture.
- 1.2 Refer to Table 1 for Superpave and conventional mix nomenclature equivalents. Replace conventional nomenclature with the Superpave nomenclature when required.

**Table 1
Nomenclatures and Definitions**

Nomenclatures		Definitions
Conventional	Superpave	
AC	-	Asphalt Content
A_g	P_s	Percent by weight of aggregate in the mixture
A_s	P_b	Percent by weight of asphalt binder in the mixture
G_a	G_{mb}	Bulk specific gravity of compacted specimens
G_e	G_{se}	Effective specific gravity of the combined aggregates
G_r	G_{mm}	Theoretical maximum specific gravity
G_{rc}	G_{mm}	Theoretical maximum specific gravity corrected for water absorption during test
G_s	G_b	Specific gravity of the asphalt binder determined at 77°F (25°C)
G_t	$G_{max-theo}$	Calculated theoretical maximum specific gravity of the mixture at the specified AC

- 1.3 The values given in parentheses (if provided) are not standard and may not be exact mathematical conversions. Use each system of units separately. Combining values from the two systems may result in nonconformance with the standard.

2. DEFINITIONS

- 2.1 *Bulk Specific Gravity (G_a)*—the ratio of the weight of the compacted bituminous mixture specimen to the bulk volume of the specimen.

- 2.2 *Percent Density or Percent Compaction*—the ratio of the actual G_a of the compacted bituminous mixture specimen to the theoretical maximum specific gravity of the combined aggregate and asphalt contained in the specimen expressed as a percentage.

PART I—BULK SPECIFIC GRAVITY OF COMPACTED BITUMINOUS MIXTURES

3. SCOPE

- 3.1 Use this procedure for all compacted bituminous mixtures, except use Part VI for mixtures with more than 2.0% water absorption.

4. APPARATUS

- 4.1 *Balance*, Class G2 in accordance with Tex-901-K, minimum capacity of 10,000 g, equipped with suitable apparatus to permit weighing the specimen while suspended in water.
- 4.2 *Suspension Apparatus, Non-Absorptive String, Metal Bucket, or a Cage*, attached to the balance with a metal wire or a non-absorptive string.
- 4.3 *Mercury Thermometer*, marked in 2°F (1°C) divisions or less, or digital thermometer, capable of measuring the temperature specified in the test procedure.
- 4.4 *Water Bath with a Tank Heater and Circulator*, for immersing the specimen in water while suspended, equipped with an overflow outlet for maintaining a constant water level.
- 4.5 *Towel*, suitable for surface drying the specimen.
- 4.6 *Vacuum Device*, such as Coredryer (optional).
- 4.7 *Measuring Device*, such as a ruler, calipers, or measuring tape.
- 4.8 *Drying Oven*, capable of attaining the temperature specified in the test procedure.

5. TEST SPECIMENS

- 5.1 Test specimens may be laboratory-molded mixtures or pavement cores.
- 5.2 Avoid distorting, bending, or cracking the specimens during and after removal from pavements or molds. Store the specimens in a cool place.
- 5.3 Obtain cores in accordance with Tex-251-F, Part I.
- 5.4 *Laboratory-Molded Specimens:*
- 5.4.1 Measure and record the specimen height to the nearest 1/16 in.
- 5.5 *Pavement Cores*
- 5.5.1 Prepare pavement cores for testing in accordance with Tex-251-F, Part II.

6. PROCEDURES

- 6.1 For specimens containing moisture, follow the instructions in Sections 6.2–6.9. For laboratory-molded specimens, perform the instructions in Sections 6.3–6.9.
- 6.2 Place the specimen in an oven with the flat side of the specimen on a flat surface to complete the drying process. Oven-dry the specimen for a minimum of two hr. at a temperature of $115 \pm 5^\circ\text{F}$ ($46 \pm 3^\circ\text{C}$) to constant weight. “Constant weight” is the weight at which further oven drying does not alter the weight by more than 0.05% in a two hr. or longer drying interval when calculated in accordance with Section 7.1.
- Note 1**—The oven drying temperature can be reduced to a temperature no lower than 100°F (38°C) provided that the specimen remains in the oven for a minimum of eight hr.
- Note 2**—As an option, for specimens not subject to further testing and evaluation, rapid dry in an oven at a temperature of 140°F (60°C), for a maximum of 12 hr. to constant weight.
- Note 3**—As an option, use a Coredryer in conjunction with or instead of a drying oven. Dry all samples to a constant weight as defined in Section 6.2.
- 6.3 Allow the specimen to cool, and then weigh in air to the nearest 0.1 g.
- 6.4 Record and designate this weight as *A* in Section 7.2.
- 6.5 Unplug or turn off the water circulator in the water bath while obtaining the submerged sample weight. Attach the suspension apparatus to the scale and submerge in water. Tare the scale with the suspension apparatus submerged in water.
- 6.6 Immerse the specimen in a water bath at $77 \pm 3^\circ\text{F}$ ($25 \pm 2^\circ\text{C}$).
- 6.7 Leave the sample in the water for three min. \pm 15 sec. When the scale readings stabilize, record the specimen weight and designate as *C* in Section 7.2.
- 6.8 Remove the specimen from water. Dry the surface of the specimen by blotting gently with a damp towel for no longer than 20 sec. To facilitate drying, gently rotate the specimen while blotting, if necessary; however do not shake, sling, or perform any action that removes water from within the specimen.
- 6.9 Weigh the specimen in air. Record as the saturated surface dry weight (SSD) and designate as *B* in Section 7.2.
-

7. CALCULATIONS

- 7.1 Calculate the percent difference in weight:

$$\text{PercentDifference} = \left(\frac{\text{InitialWeight} - \text{FinalWeight}}{\text{InitialWeight}} \right) * 100$$

- 7.2 Calculate G_a and percent of water absorbed by the specimen:

$$G_a = \frac{A}{B - C}$$

Where:

G_a = bulk specific gravity,

A = weight of dry specimen in air, g,

B = weight of the SSD specimen in air, g, and

C = weight of the specimen in water, g.

$$\text{Percent absorption} = \frac{B - A}{B - C} \times 100$$

Where:

A = weight of dry specimen in air, g,

B = weight of the SSD specimen in air, g, and

C = weight of the specimen in water, g.

Note 4—If the percent absorption exceeds 2.0%, use Part VI.

PART II—BULK SPECIFIC GRAVITY OF COMPACTED BITUMINOUS MIXTURES USING PARAFFIN

8. SCOPE

- 8.1 The paraffin method is no longer an accepted process.
- 8.2 Refer to Part VI of this test procedure for absorptive mixtures (those with more than 2.0% water absorption).

PART III—DETERMINING IN-PLACE DENSITY OF COMPACTED BITUMINOUS MIXTURES (NUCLEAR METHOD)

9. SCOPE

- 9.1 Use this procedure to determine the in-place density of compacted bituminous mixtures using a nuclear density gauge.

10. APPARATUS

- 10.1 *Nuclear Density Gauge.*
- 10.2 *Portable Reference Standard.*
- 10.3 *Calibration Curves for the Nuclear Gauge.*
- 10.4 *Scraper Plate and Drill Rod Guide.*
- 10.5 *Drill Rod and Driver or Hammer.*
- 10.6 *Shovel, Sieve, Trowel, or Straightedge and Miscellaneous Hand Tools.*

10.7 Gauge Logbook.

11. STANDARDIZATION

- 11.1 To standardize the nuclear density gauge, turn on the apparatus and allow it to stabilize.
Note 5—Follow the manufacturer’s recommendations to ascertain the most stable and consistent results.
- 11.2 Perform standardization with the apparatus located at least 25 ft. (8 m) away from other sources of radioactivity. Clear the area of large masses or other items that may affect the reference count rate.
Note 6—The preferred location for standardization checking is the pavement location tested. This is the best method for determining day-to-day variability in the equipment.
- 11.3 Take a minimum of four repetitive readings using Table 2 at the normal measurement period, and determine the average of these readings.
Note 7—One measurement period of four or more times the normal period is acceptable if available on the apparatus. This constitutes one standardization check.
- 11.4 Detect the total number of gammas during the period by determining the count per measurement period. Correct the displayed value for any prescaling built into the instrument. Record this corrected value as N_s .
Note 8—The prescale value (F) is a divisor, which reduces the actual value for the purpose of display. The manufacturer will supply this value if other than 1.0.
- 11.5 Use the value of N_s to determine the count ratios for the current day’s use of the instrument.
Note 9—Perform another standardization check if for any reason the measured density becomes suspect during the day’s use.
- 11.6 Table 2 lists the required actions to take based on the results from Section 11.3.

**Table 2
Reference Standard**

If . . .	Then . . .
the value obtained is within the limits stated in limits calculation	the apparatus is considered to be in satisfactory operating condition and the value may be used to determine the count ratios for the day of use.
the value is outside these limits	allow additional time for the apparatus to stabilize, make sure the area is clear of sources of interference, then conduct another standardization check.
the second standardization check is within the limits	the apparatus may be used.
the second standardization check also fails the test	the apparatus must be adjusted or repaired as recommended by the manufacturer.

12. CALCULATIONS

12.1 Use the test results from Section 11.3 and the following calculations to determine the limit:

$$(N_s - N_o) \leq 2.0\sqrt{N_o / F}$$

Where:

N_s = value of current standardization count

N_o = average of the past four values of N_s taken previously

F = value of any prescale.

13. PROCEDURE

- 13.1 To determine the in-place density using a nuclear density gauge, select an area that is relatively free of loose material, voids, or depressions. Avoid elevating the gauge above the surface of the material to be tested.
Note 10—Select an area at least 12 in. (0.3 m) away from surface obstructions such as curbing, etc. It is optional to use fine sand to fill any voids or minor depressions.
- 13.2 Measure the density of the selected area in either the backscatter or direct transmission mode.
Note 11—The direct transmission method is only applicable for lifts greater than two in. (50 mm) thick.
- 13.3 Follow the instructions in Sections 13.3.1–13.3.2 to measure the in-place density of compacted bituminous pavements using a nuclear density gauge in the backscatter mode.
- 13.3.1 Firmly seat the density gauge on the selected area so it is in full contact with the surface.
- 13.3.2 Record the readings that are required at each location with the probe in the backscatter position. Do not leave the gauge in one position on the compacted bituminous pavement for a long time, as erratic readings may result from the hot surface. Proceed to Section 13.5.
- 13.4 Follow the instructions in Sections 13.4.1–13.4.4 to measure the in-place density of compacted bituminous pavements using a nuclear density gauge in the direct transmission mode.
- 13.4.1 Make a hole two in. (50 mm) deeper than the transmission depth used with the drive pin and guide plate.
Note 12—The hole must be as close as possible to 90° from the plane surface.
- 13.4.2 Firmly seat the density gauge on the prepared area so it is in full contact with the surface.
- 13.4.3 Adjust the probe to the desired transmission depth. Pull the gauge so that the probe is in contact with the side of the hole nearest the detector tubes.
- 13.4.4 Measure and record the readings required for each location for the particular type of gauge used. Proceed to Section 13.5.
- 13.5 Use one of the following methods to determine the in-place density.
- 13.5.1 Divide the field counts by the standard counts.
OR
- 13.5.2 Use the appropriate calibration curves, if necessary.
Note 13—Most models are now programmable to provide direct reading of the nuclear density or percent compaction.
- 13.6 Take cores or sections of the pavement from the same area selected for the nuclear tests when correlating the nuclear density to the actual density of the compacted material.
- 13.7 Measure the G_a of the cores or samples taken from the selected area tested for density as described in Part I or Part VI. Establish a correlation factor using a minimum of seven core densities and seven nuclear

densities. Adjust the nuclear density readings using this correlation factor to correlate with the actual G_a determined through laboratory testing.

Note 14—When testing thin lifts in the backscatter mode, the influence of underlying strata with varying densities may render this procedure impractical without special planning. Most manuals for the nuclear gauge describe the various methods to use with thin lifts.

- 13.8 Make correlations as described in Section 13.6 and compare the correlated nuclear density to the G_r or G_{rc} of the mixture when controlling in-place density with the nuclear gauge. Calculate the percent density or directly read from programmable models to determine air-void content.

PART IV—ESTABLISHING ROLLER PATTERNS (CONTROL STRIP METHOD)

14. SCOPE

- 14.1 Use this procedure to establish roller patterns for bituminous pavement.

15. APPARATUS

- 15.1 *Nuclear Density Gauge.*
- 15.2 *Electrical Impedance (Nonnuclear) Density Measurement Gauge (Optional).*
- 15.3 *Portable Reference Standard.*
- 15.4 *Calibration Curves for the Nuclear Gauge.*
- 15.5 *Scraper Plate and Drill Rod Guide.*
- 15.6 *Drill Rod and Driver or Hammer.*
- 15.7 *Shovel, Sieve, Trowel, or Straightedge and Miscellaneous Hand Tools.*
- 15.8 *Gauge Logbook.*

16. PROCEDURE

- 16.1 To establish roller patterns (control strip method), refer to the gauge manufacturer's instructions for operating the density gauge.
Note 15—Standardize the equipment at the start of each day's use as described in Part III when using a nuclear density gauge.
Note 16—Operate electrical impedance (nonnuclear) gauges in continuous mode to ensure all data is from the location in question.
- 16.2 Establish a control strip approximately 300 ft. (90 m) long and at least 12 ft. (3.5 m) wide or the width of the paving machine. Select three test sites.
Note 17—Avoid areas near edges or overlap of successive passes of the rollers.
- 16.3 Allow the roller to complete a minimum of two coverages of the entire control strip before checking the density. Perform density tests at the three test sites selected. Record the results. Mark each test site very

carefully so that subsequent tests made are in the same position and location. Use a colored marker keel to outline the gauge before taking the readings. Take the tests as quickly as possible and release rollers to complete additional coverage to prevent cooling of unrolled areas.

- 16.4 Repeat the density tests at the previously marked test sites. Continue this process of rolling and testing until there is no significant increase in density. Try several different combinations of equipment, and numbers of passes with each combination, to determine the most effective rolling pattern.
- Note 18**—In-place density determined with roadway cores is the final measure of rolling pattern effectiveness.
- 16.5 Construct another section, without interruption, using the roller patterns and number of coverages determined by the control strip after completion of the control strip tests. Take random density tests on this section to verify the results from the control strip.
- Note 19**—It may be possible to reduce the required coverages based on these tests.
- 16.6 Make density tests for job control in accordance with the [Guide Schedule of Sampling and Testing](#) or as often as necessary, when some changes in the compacted material indicate the need.

17. NOTES

- 17.1 Visual observation of the surface being compacted is a very important part of this procedure. Cease rolling and get an evaluation of the roller pattern if obvious signs of distress develop, such as cracking, shoving, etc. Structural failures due to over-compaction will cause the density tests to indicate the need for more compaction. Observe closely and take particular care when using vibratory rollers, since they are more likely to produce over-compaction in the material.
- 17.2 Use the minimum test time allowed by the particular gauge when measuring density on hot material, since the gauge may display erratic results if overheated.
- 17.3 Exercise particular care to clean the bottom of the gauge after using it on asphalt pavement.
- 17.4 Use the correlation procedures outlined in Part III, Section 13.7 when using specified density and rolling patterns with a nuclear density gauge.
- 17.5 This procedure provides a general guide to establish roller patterns. Follow the manufacturer's instruction manual furnished with the particular density gauge for specific operation of that gauge. This is essential, since several different models and different brands are in standard use by the Department.
- 17.6 Nuclear gauges and the user of the nuclear gauges must meet all requirements of the Department's radioactive material license, "Nuclear Gauge Operating Procedures," and the *Texas Rules for Control of Radiation*.

PART V—DETERMINING MAT SEGREGATION USING A DENSITY-TESTING GAUGE

18. SCOPE

- 18.1 Use this procedure to identify segregation in bituminous pavements after placement on the roadway using a density-testing gauge.

19. APPARATUS

- 19.1 *Nuclear Density Gauge.*
 - 19.2 *Thin Lift Density Gauge (Optional).*
 - 19.3 *Electrical Impedance (Nonnuclear) Measurement Gauge (Optional).*
 - 19.4 *Measuring Tape (Optional).*
-

20. REPORT FORMS

- 20.1 Use [Segregation Density Profile Form](#) to identify segregation in a pavement section.
-

21. PROCEDURE

- 21.1 Refer to the manufacturer's instructions for operating the density gauge.
Note 20—It is not necessary to calibrate the gauge to the mix.
Note 21—Operate electrical impedance (nonnuclear) gauges in continuous mode to ensure all data is from the location in question.
- 21.2 Profile a 50 ft. (15 m) section of the bituminous pavement.
- 21.3 When profiling a location where the paver stopped for more than 60 sec., perform the instructions in Sections 21.3.1–21.3.3.
 - 21.3.1 Identify the location where the paver stopped paving, such as sporadic mix delivery.
 - 21.3.2 Move approximately 10 ft. (3 m) behind the location where the paver stopped paving, and mark and record this location as the beginning of the profile section.
 - 21.3.3 Proceed to Section 21.6.
- 21.4 When profiling a random location, randomly select an area, and then choose an area with visible segregation, if possible. Proceed to Section 21.6.
- 21.5 When profiling an area with segregation of longitudinal streaking greater than the profile length, perform the instructions in Sections 21.5.1–21.5.5.
 - 21.5.1 Profile the area at an angle in a diagonal direction.
 - 21.5.2 Start the profile with a transverse offset of 2 ft. (0.6 m) from the center of the longitudinal streak.
 - 21.5.3 End profile with a transverse offset of 2 ft. (0.6 m) on the opposite side of the longitudinal streak.
 - 21.5.4 Do not start or end a profile less than 1 ft. (0.3 m) from the pavement edge.
 - 21.5.5 Proceed to Section 21.7.
- 21.6 Determine the transverse offset 2 ft. (0.6 m) or more from the pavement edge. Take density readings in a longitudinal direction and do not vary from this line. Visually observe the mat and note the surface texture in

the section and the location of any visible segregated areas. Take additional readings along the transverse offset in areas with visible segregation. Include any visually segregated areas in the profile.

- 21.7 After completion of the final rolling patterns, position the density gauge at the identified location.
- 21.7.1 *Use of a Nuclear Density Gauge:*
- 21.7.1.1 Take three one min. readings (minimum time length, longer readings can be used) in backscatter mode when using a nuclear density gauge at each random sample location.
- 21.7.1.2 It is optional to use fine sand passing the No. 40 sieve size to fill any voids without elevating the gauge above the rest of the mat.
- 21.7.2 *Use of an Electrical Impedance Gauge:*
- 21.7.2.1 Take two readings; it is not necessary to move the gauge between readings.
Note 22—Operate electrical impedance (nonnuclear) gauges in continuous mode to ensure all data is from the location in question.
- 21.8 Record the in-place density gauge readings.
- 21.9 Average the readings before moving the density gauge. Compare each individual reading to the average. Discard any single readings that vary more than 1 pcf (16 kg/m³) from the average. Take additional readings to replace the discarded readings until all the readings are within 1 pcf (16 kg/m³) of the average.
- 21.10 Move the density gauge approximately 5 ft. (1.5 m) forward in the direction of the paving operation. Take an additional set of readings at any location with visible segregation in between the 5 ft. (1.5 m) distance.
- 21.11 Repeat the instructions in Sections 21.7–21.10. Complete a minimum of 10 sets of readings.
Note 23—Use a nuclear density gauge to verify impedance gauge readings whenever readings from an impedance gauge may not be accurate.
- 21.12 Determine the average density from all locations.
- 21.13 Determine the difference between the highest and lowest average density.
- 21.14 Determine the difference between the average and lowest average density.
- 21.15 Record the data using the [Example Segregation Profile Worksheet](#).

PART VI—BULK SPECIFIC GRAVITY OF COMPACTED BITUMINOUS MIXTURES USING THE VACUUM METHOD

22. SCOPE

- 22.1 Use this procedure to determine the G_a of compacted bituminous mixtures using the vacuum device. This procedure is applicable for mixtures with more than **2.0% water absorption**.

23. APPARATUS

- 23.1 *Specialized Vacuum Sealing Device.*

- 23.2 *Balance*, Class G2 in accordance with Tex-901-K, minimum capacity of 10,000 g, equipped with suitable apparatus to permit weighing of the specimen while suspended in water.
- 23.3 *Suspension Apparatus, Non-Absorptive String, Metal Bucket, or Cage*, attached to the balance with a metal wire or a non-absorptive string.
- 23.4 *Mercury Thermometer*, marked in 2°F (1°C) divisions or less, or digital thermometer, capable of measuring the temperature specified in the test procedure.
- 23.5 *Water Bath with a Tank Heater and Circulator*, for immersing the specimen in water while suspended from a scale, equipped with an overflow outlet for maintaining a constant water level.
- 23.6 *Vacuum Device*, such as Coredryer (optional).
- 23.7 *Measuring Device*, such as a ruler, calipers, or measuring tape.
-

24. TEST SPECIMENS

- 24.1 Test specimens may be laboratory-molded mixtures or pavement cores.
- 24.2 Avoid distorting, bending or cracking the specimens during and after removal from pavements or molds. Store the specimens in a cool place.
- 24.3 Obtain cores in accordance with Tex-251-F, Part I.
- 24.4 *Laboratory-Molded Specimens:*
- 24.4.1 Measure and record the specimen height to the nearest 1/16 in.
- 24.5 *Pavement Cores:*
- 24.5.1 Prepare pavement cores for testing in accordance with Tex-251-F, Part II.
-

25. MATERIALS

- 25.1 Use a supply of large and small-specialized polymer bags as recommended by the manufacturer.
-

26. PROCEDURES

- 26.1 *Vacuum Sealing Device Setup:*
- 26.1.1 Set the vacuum timer.
- Note 24**—The manufacturer calibrates the vacuum pump timer setting and exhaust at the factory to eliminate drift and variability due to the sealing process. The vacuum pump operates for approximately one min. Contact the manufacturer for adjustments if the vacuum pump stops before this time has elapsed.
- 26.1.2 Set the sealing bar timer in accordance with the vacuum device manufacturer's recommendations.
- Note 25**—Inspect the seal quality after the first sealing operation. Reduce the setting if the polymer bag stretches or burns. Increase the setting if the seal is not complete or the bag easily separates.
- 26.2 *Determine the G_a of Compacted Bituminous Mixtures:*
-

- 26.2.1 Perform the instructions in Sections 26.2.2–26.2.3 for specimens containing moisture. Proceed to Section 26.2.4 for laboratory-molded specimens.
- 26.2.2 Proceed to Section 26.2.3 or, as an option, pre-dry the specimen using a Coredryer or air dry to remove excess moisture.
- 26.2.3 Place the specimen in an oven with the flat side of the specimen on a flat surface. Oven-dry the specimen for a minimum of two hr. at a temperature of $115 \pm 5^\circ\text{F}$ ($46 \pm 3^\circ\text{C}$) to a constant weight. “Constant weight” is the weight at which further oven drying does not alter the weight by more than 0.05% in a two hr. or longer drying interval in accordance with Section 7.1. Refer to Part I, Notes 3 and 4.
- 26.2.4 Allow the specimen to cool to room temperature, and then weigh in air to the nearest 0.1 g. Record and designate this weight as *A* in Section 27.1.
- 26.2.5 Open the lid of the vacuum device. Stack or remove rectangular spacer plates in the vacuum chamber of the vacuum device so there is adequate space for the test specimen.
- 26.2.6 Place a sliding plate in the vacuum chamber on top of the spacer plates away from the seal bar.
Note 26—Place the sliding plate in the chamber to reduce friction during the sealing operation.
- 26.2.7 Select and use a large or small polymer bag, as recommended by the manufacturer, to seal the specimen.
- 26.2.8 Weigh the selected polymer bag and record and designate this weight as *B* in Section 27.1.
- 26.2.9 *Determine the Polymer Bag Correction Factor (CF):*
- 26.2.9.1 Calculate the ratio, *R*, by dividing the weight of the specimen by the weight of the bag.
- 26.2.9.2 Use the CF Table provided in the manufacturer’s operator guide.
- 26.2.9.3 Look up the calculated *R*-value and record and designate the corresponding correction factor from the table as *CF* in Section 27.1.
- 26.2.10 *Vacuum Seal the Specimens:*
- 26.2.10.1 Place the bag inside the chamber.
- 26.2.10.2 Place the specimen in the polymer bag, carefully avoiding puncturing or tearing the bag.
- 26.2.10.3 Center the core in the bag, leaving approximately 1 in. (25.4 mm) of slack on the backside.
- 26.2.10.4 Position the bag so that approximately 1 in. (25.4 mm) of the open end is evenly against the sealing bar.
- 26.2.10.5 Close the lid of the vacuum device and hold firmly for two to three sec.
Note 27—The vacuum pump will start, and the lid will stay closed on its own. The vacuum gauge will read less than 28 in. (50 mm) Hg.
- 26.2.10.6 The lid of the vacuum device will automatically open upon completion of the sealing process. Carefully remove the sealed specimen from the chamber. Gently pull on the polymer bag to ensure the seal is tightly conformed to the specimen. Return to the instructions in Section 26.2.8 if the seal is not tightly conformed to the specimen.
Note 28—A loose seal may be an indication of a leak.
- 26.2.11 Determine the type of apparatus to use to weigh the samples suspended in water.

- 26.2.12 Unplug or turn off the water circulator in the water bath while obtaining the submerged sample weight. Attach the apparatus to the scale and submerge in water. Tare the scale with the apparatus submerged in water.
- 26.2.13 Completely submerge the sealed specimen in water at $77 \pm 3^\circ\text{F}$ ($25 \pm 2^\circ\text{C}$) and record the weight of the specimen in the bag. Weigh the sealed specimen in water. Record the weight to the nearest 0.1 g when the scale reading stabilizes. Designate this weight as *C* in Section 27.1.
Note 29—Do not allow the polymer bag to touch the sides of the water bath.
- 26.2.14 Remove the specimen from the polymer bag and reweigh the specimen in air. Compare this weight to the weight recorded for *A* in Section 26.2.4. If the difference in weight is greater than 5 g, a leak may have occurred. Dry the sample to a constant weight and repeat the procedure using a new polymer bag.
- 26.3 Do not use the test results calculated in this test procedure using the vacuum device if this method produces a G_a that is higher than the G_a calculated in Part I.
Note 30—Use the results calculated in Part I of this method in this case.

27. CALCULATIONS

- 27.1 Calculate the G_a of the compacted specimen:

$$G_a = \frac{A}{[(A + B) - C] - \frac{B}{CF}}$$

Where:

G_a = bulk specific gravity,

A = weight of specimen in air, g,

B = weight of the polymer bag in air, g,

C = weight of sealed specimen in water, g, and

CF = correction factor.

PART VII—DETERMINING LONGITUDINAL JOINT DENSITY USING A DENSITY-TESTING GAUGE

28. SCOPE

- 28.1 Use this procedure to perform a longitudinal joint density evaluation on bituminous pavement using a density-testing gauge.

29. APPARATUS

- 29.1 *Nuclear Density Gauge.*
- 29.2 *Thin Lift Density Gauge (Optional).*
- 29.3 *Electrical Impedance (Nonnuclear) Density Measurement Gauge (Optional).*

29.4 Measuring Tape (Optional).

30. FORMS

30.1 [Longitudinal Joint Density Profile Form.](#)

31. PROCEDURES

31.1 *Perform a Longitudinal Joint Density Using a Density-Testing Gauge:*

31.1.1 Refer to the manufacturer's instructions for operating the density gauge.

31.1.2 Identify the random sample location selected for in-place air void testing. Mark and record this location as the reference point to perform the joint evaluation.

Note 31—This point must be more than 2 ft. (0.6 m) from the pavement edge.

31.1.3 Position the gauge at the random sample location selected for in-place air void testing identified in Section 36.1.2 after completion of the final rolling pattern.

31.1.3.1 *Use of a Nuclear Density Gauge:*

31.1.3.1.1 Take three one min. readings (minimum time length, longer readings can be used) in backscatter mode when using a nuclear density gauge.

31.1.3.1.2 It is optional to use fine sand passing the No. 40 sieve size to fill any voids without elevating the gauge above the rest of the mat.

31.1.3.2 *Use of an Electrical Impedance Gauge:*

31.1.3.2.1 Take two readings; it is not necessary to move the gauge between readings.

Note 32—Operate electrical impedance (nonnuclear) gauges in continuous mode to ensure all data is from the location in question.

31.1.4 Record the density measurements from the density gauge at the random sample location selected for in-place air void testing.

31.1.5 Measure the longitudinal joint density at the right and left edge of the mat, which is or will become a longitudinal joint.

Note 33—Select a location that is perpendicular to the random sample location selected for in-place air void testing.

Identify the joint type as "Confined" or "Unconfined."

Note 34—Take additional readings along the longitudinal joint at areas with visible irregularities or segregation.

31.1.6 Position the gauge with the center placed 8 in. (200 mm) from the pavement edge that is or will become a longitudinal joint. Orient the gauge so the longer dimension of the gauge is parallel to the longitudinal joint.

31.1.6.1 *Use of a Nuclear Density Gauge:*

31.1.6.1.1 Take three one min. readings (minimum time length, longer readings can be used) in backscatter mode when using a nuclear density gauge.

- 31.1.6.1.2 It is optional to use fine sand passing the No. 40 sieve size to fill any voids without elevating the gauge above the rest of the mat.
- 31.1.6.2 *Use of an Electrical Impedance Gauge:*
- 31.1.6.2.1 Take two readings; it is not necessary to move the gauge between readings.
Note 35—Operate electrical impedance (nonnuclear) gauges in continuous mode to ensure all data is from the location in question.
- 31.1.7 Record the density measurements from the density gauge at the longitudinal joint.
- 31.1.8 Determine the difference in density between the readings taken at the random sample location selected for in-place air void testing and the readings taken at the longitudinal joint.
Note 36—Use a nuclear density gauge to verify impedance gauge readings whenever readings from an impedance gauge may not be accurate.
- 31.1.9 Record and report the data using the [Example Longitudinal Joint Density Worksheet](#).
- 31.2 *Determine a Correlated Joint Density:*
- 31.2.1 Record the average G_a of the cores taken at the random sample location selected for in-place air voids (A).
- 31.2.2 Record the G_r for each subplot evaluated for joint density (B).
- 31.2.3 Record the average density gauge reading in pcf (kg/m^3) at the longitudinal joint sample location for in-place air voids (C).
- 31.2.4 Record the average density gauge reading in pcf (kg/m^3) at the interior mat random sample location for in-place air voids (D).
- 31.2.5 Record and report the data using the Example Longitudinal Joint Density Worksheet.

32. CALCULATIONS

- 32.1 Calculate the correlated joint density, CJD (%) of the compacted specimen:

$$CJD(\%) = \frac{A}{B} \times \frac{C}{D} \times 100$$

Where:

A = Average G_a of cores at random sample location,

B = Rice gravity, G_r , for each subplot,

C = Average density gauge reading at the longitudinal joint, pcf (kg/m^3), and

D = Average density gauge reading at the interior mat sample location, pcf (kg/m^3).

PART VIII—DETERMINING DENSITY OF PERMEABLE FRICTION COURSE (PFC) AND THIN BONDED WEARING COURSE (TBWC) MIXTURES

33. SCOPE

- 33.1 Use this procedure to back-calculate the G_r of loose PFC and TBWC mixtures, to calculate the G_a of laboratory-molded specimens for PFC and TBWC mixtures using dimensional analysis, and to calculate density of compacted PFC and TBWC mixtures.

34. APPARATUS

- 34.1 *Measuring Device*, such as a ruler, calipers, or measuring tape.

35. PROCEDURE

- 35.1 Back calculate G_r .
- 35.1.1 Obtain the G_e of the combined aggregate blend.
Note 37—Obtain the G_e from the Summary worksheet of the [Mix Design Template](#).
- 35.1.2 Record and designate this as G_e in Section 36.1.
- 35.1.3 Determine the AC of the PFC or TBWC mixture.
Note 38—Determine the AC of PFC-Asphalt Rubber (AR) mixtures by using the asphalt flow meter. Determine the AC of PFC PG 76 mixtures using an ignition oven in accordance with Tex-236-F or by using the asphalt flow meter
- 35.1.4 Record and designate this as A_s in Section 36.1.
- 35.1.5 Determine the specific gravity of the asphalt binder. Round to three decimal places (0.001).
- 35.1.6 Record and designate this as G_s in Section 36.1.
- 35.1.7 Calculate G_r as noted in Section 36.1.
- 35.2 Calculate G_a using dimensional analysis.
- 35.2.1 Measure the weight of the laboratory molded specimen in air, to the nearest 0.1 g.
- 35.2.2 Record and designate this weight as W in Section 36.2.
- 35.2.3 Measure the height of the laboratory-molded specimen, to the nearest 0.1 mm.
- 35.2.4 Record and designate this height as h in Section 36.2.
- 35.2.5 Measure the diameter of the laboratory-molded specimen, to the nearest 0.1 mm.
Note 39—The diameter for specimens molded with a Superpave Gyratory Compactor is 150 mm.

- 35.2.6 Calculate the radius of the laboratory-molded specimen by dividing the diameter, as determined in Section 34.2.5, by 2.
Note 40—The radius for specimens molded with a Superpave Gyratory Compactor is 75 mm.
- 35.2.7 Record and designate this as r in Section 36.2.
- 35.2.8 Calculate G_a as noted in Section 36.2.
Note 41—Numerical value for π is 3.14.
- 35.3 Calculate density of compacted PFC or TBWC mixture.
- 35.3.1 Divide the G_a determined in Section 35.2.8 by the G_r determined in Section 35.1.7.
- 35.3.2 Multiply the results from Section 35.3.1 by 100.
Note 42—Round this calculated value to the tenth decimal place (0.1).

36. CALCULATIONS

- 36.1 Calculate the G_r of the loose PFC or TBWC mixture:

$$G_r = \frac{100}{\left[\left(\frac{100 - A_s}{G_e} \right) + \left(\frac{A_s}{G_s} \right) \right]}$$

Where:

G_r = theoretical maximum specific gravity,

G_e = effective specific gravity, %,

A_s = AC, %, and

G_s = asphalt binder specific gravity, 0.001.

- 36.2 Calculate the G_a of the compacted specimen:

$$G_a = \frac{\left[\frac{W}{\pi r^2 h} \right]}{\gamma}$$

Where:

G_a = bulk specific gravity,

W = weight of specimen, 0.1 g,

π = pi, 3.14,

r = radius of specimen, 1 mm,

h = height of specimen, 0.1 mm, and

γ = density of water, 0.001 g/mm³.

37. REPORT FORMAT

- 37.1 Use the following Excel programs to calculate and report density test results.

- 37.1.1 Quality Control/Quality Assurance (QC/QA), used in conjunction with the hot mix specification and test data worksheets. Refer to the “Help” tab for detailed instructions on how to use the program.
 - 37.1.2 [Segregation Density Profile Form.](#)
 - 37.1.3 [Longitudinal Joint Density Profile Form.](#)
-

38. ARCHIVED VERSIONS

- 38.1 Archived versions are available.



Tex-207-F (Part 5), Segregation Profile

Location	DENSITY READINGS		Average
	1	2	
0'	146.3	145.2	
5'	146.0	148.0	
10'	148.0	149.2	
15'	145.6	144.5	145.1
20'	136.0	136.2	136.1
25'	148.9	148.0	148.5
30'	144.9	146.9	145.9
35'	143.8	143.0	143.4
40'	144.0	146.0	145.0
45'	144.0	144.0	144.0
50'	145.7	145.9	145.8
Average Reading:			
High Reading:			
Low Reading:			
Highest to Lowest:			
Average to Lowest:			

Calculation

- Average Reading = Average of all the Average Readings
- High Reading = Highest Reading of the Averages
- Low Reading = Lowest Reading of the Averages
- Highest to Lowest = High Reading – Low Reading
- Average to Lowest = Average Reading – Low Reading



Tex-207-F (Part VII) LONGITUDINAL JOINT DENSITY

Type of Density Gauge:	Non-Nuclear			
Lot #	2			
Sublot #	1	2	3	4
Station/ID Number	137+25	141+50	145+75	150+00
Travel Lane				

LEFT LONGITUDINAL JOINT

Type of Longitudinal Joint:		Unconfined				
Sublot #		1	2	3	4	
LEFT MAT EDGE LONGITUDINAL JOINT DENSITY	Gauge Readings (lbs/cf)	1	136.6	138.8	137.5	139.7
		2	137.2	138.3	138.4	140.1
		Average	136.9	138.6	138.0	139.9
INTERIOR MAT DENSITY	Gauge Readings (lbs/cf)	1	139.4	141.0	140.3	142.9
		2	139.7	141.9	140.7	143.1
		Average	139.6	141.5	140.5	143.0
Density Difference Interior & Left Mat Edge						

RIGHT LONGITUDINAL JOINT

Type of Longitudinal Joint:		Confined				
Sublot #		1	2	3	4	
RIGHT MAT EDGE LONGITUDINAL JOINT DENSITY	Gauge Readings (lbs/cf)	1	138.7	139.8	139.2	140.1
		2	138.4	138.4	139.6	139.5
		Average	138.6	139.1	139.4	139.8
INTERIOR MAT DENSITY	Gauge Readings (lbs/cf)	1	139.4	141.0	140.3	142.9
		2	139.7	141.9	140.7	143.1
		Average	139.6	141.5	140.5	143.0
Density Difference Interior & Right Mat Edge						

CORRELATED JOINT DENSITY, %

Sublot #		1	2	3	4	
Interior Mat Density	Roadway Core Bulk Specific Gravity	Core # 1 Ga	2.228	2.230	2.222	2.232
		Core # 2 Ga	2.233	2.295	2.231	2.230
		Average Ga	2.231	2.263	2.227	2.231
Rice Gravity, Gr:		2.430	2.429	2.417	2.433	
Correlated Joint Density	Left Mat Edge					
	Right Mat Edge					

Test Procedure for**SAMPLING BITUMINOUS MIXTURES**

TxDOT Designation: Tex-222-F

Effective Date: January 2016

1. SCOPE

- 1.1 Use this test method to sample mixtures of bituminous materials. Several sampling procedures are described.
 - 1.2 The values given in parentheses (if provided) are not standard and may not be exact mathematical conversions. Use each system of units separately. Combining values from the two systems may result in nonconformance with the standard.
-

2. SELECTING SAMPLES

- 2.1 Use every precaution to obtain representative samples of the bituminous mixtures, to avoid segregation, and to prevent contamination by foreign matter.
 - 2.2 Attach [Form 202](#), "Identification of Material Samples," to each sample container.
-

3. SAMPLE SIZE

- 3.1 When sampling any type of bituminous mixture for future laboratory testing, the minimum sample size will fill a 1-gal. (4-L), clean, friction-top bucket.
 - 3.2 If extensive testing is desired, sample 2 or more buckets of the material, as required. Blend all sampled materials to form a composite sample prior to quartering to size for laboratory tests.
-

4. SAMPLING PROCEDURES

- 4.1 *Sampling Plant-Mixed Bituminous Mixtures:*
 - Note 1**—Provide a proper sampling stand and take adequate safety precautions to prevent bodily injury.
 - 4.1.1 *Method A*—Follow these steps to obtain samples from trucks or railroad cars.
 - 4.1.1.1 Obtain multiple representative samples from the truck bed or railroad car.
-

- 4.1.1.1.1 View the mix after loading is complete. Note areas of obvious segregation and avoid taking samples from these locations.
- 4.1.1.1.2 Take all necessary safety precautions when obtaining these samples. Avoid walking or standing on the hot mix while taking these samples.
- 4.1.1.2 Select a minimum of 3 sections in the truck bed or railcar. Dig a minimum of 12 in. (300 mm) below the surface and remove at least 10 lb. (4.5 kg) of material from each of the sections.
- 4.1.1.3 Combine and thoroughly mix together all of the samples.
- 4.1.1.4 Split the combined sample into individual samples in accordance with Tex-200-F.
- 4.1.1.5 Any individual samples allowed to cool to ambient temperatures and to be transported to another laboratory for testing must not exceed a thickness greater than 3 in.
Note 2— Recommended sampling containers are paper bags or cardboard boxes.
- 4.1.2 *Method B*—Follow these steps to obtain a plant-mixed sample.
 - 4.1.2.1 Fill the bucket of a front-end loader with mix directly from the discharge chute.
Note 3—Clean the bucket of all materials that may contaminate the sample.
 - 4.1.2.2 Take samples from several locations in the bucket to form a composite minimum sample of 30 lb. (13.5 kg).
 - 4.1.2.3 Split the combined sample into individual samples in accordance with Tex-200-F.
 - 4.1.2.4 Any individual samples allowed to cool to ambient temperatures and to be transported to another laboratory for testing must not exceed a thickness greater than 3 in.
Note 4— Recommended sampling containers are paper bags or cardboard boxes.
- 4.2 *Obtaining Bituminous Mixtures from Stockpiles at the Plant:*
 - 4.2.1 Obtain equal quantities of the mixture from holes dug into points near the top, middle, and bottom of the stockpile.
 - 4.2.1.1 Combine and thoroughly mix together all of the samples.
 - 4.2.1.2 Split the combined sample into individual samples in accordance with Tex-200-F.
- 4.3 *Sampling Bituminous Mixtures from Windrows:*
 - 4.3.1 Take a representative sample of the windrow at intervals of not more than 500 ft. (152 m).
 - 4.3.1.1 Whenever practical, secure samples from a complete cross-section of material approximately 1 ft. (100 mm) wide.

- 4.3.1.2 When the full depth of the cross-section is sampled, take care to exclude any foreign matter.
- 4.3.2 Combine and thoroughly mix together all of the samples.
- 4.3.3 Split the combined sample into individual samples in accordance with Tex-200-F.
- 4.3.4 Any individual samples allowed to cool to ambient temperatures and to be transported to another laboratory for testing must not exceed a thickness greater than 3 in.
Note 5—Recommended sampling containers are paper bags or cardboard boxes.
- 4.4 *Sampling Bituminous Mixture Cores from the Roadway:*
- 4.4.1 Sample in a cool part of the day to facilitate removal of the pavement specimen with minimum possibility of damage.
Note 6—Use ice, dry ice, or carbon dioxide to cool the pavement area to be sampled, when taking samples in full heat.
- 4.4.2 Take core samples of the diameter required by the specifications.
- 4.4.3 Remove a minimum of 2 samples at each location unless otherwise stated in the specification.
- 4.4.4 Wipe the sample surface dry with a cloth, individually wrap in paper or rags, and pack tightly in 1-gal. (4-L) buckets, if shipping to a central laboratory for testing. Sufficiently identify each individual core.
- 4.4.5 Remove large pavement samples for testing, if required.
- 4.4.6 Use the sharp, narrow cutting blade of a mattock (or other means) to pry loose a sample approximately 457 mm (18 in.) square from the roadway pavement. To prevent cracking, take extra care in removing and transporting the sample.
- 4.4.7 Place the sample between two clean pieces of 19-mm (0.75-in.) thick plywood, with the smoothest, cleanest surface of the sample down, and tie securely with heavy cord. Transport the sample with the smooth side remaining down.
- 4.4.8 To prevent evaporation of the moisture of a pavement sample, and/or the hydrocarbon volatiles of cold-laid mixtures, wrap the sample in aluminum foil.
- 4.5 *Sampling Loose Material Behind the Laydown Machine:*
- 4.5.1 Sample after approximately half of the truck load has passed through the laydown machine, either from various points in front of the screed on the machine or from various points immediately behind.
- 4.5.2 Any individual samples allowed to cool to ambient temperatures and to be transported to another laboratory for testing must not exceed a thickness greater than 3 in.
Note 7—Recommended sampling containers are paper bags or cardboard boxes.

4.6 *Sampling Asphalt Patching Mix:*

4.6.1 Approximately 40 lb. (18 kg) of sample is required for specification tests on this material.

4.6.2 Submit one sample for each 50 tons (45 Mg) or fraction thereof. (See Table 1.)

Table 1—Sampling Asphalt Patching Mix

If the material is . . .	then . . .
Purchased in 50-lb. (23-kg) pails	Select, at random, one or more pails as necessary and submit as the sample.
Supplied in 55-gal. (200-L) drums	<ul style="list-style-type: none"> ▪ Select a drum at random, open, scrape aside or remove approximately 2 in. (51 mm) of material, dig out a 14-kg (30-lb.) sample, and place in a pail. ▪ Immediately seal the pail and the 55-gal. (200-L) drum to prevent loss of volatiles.
Purchased in (40–60-lb.) sealed bags	Select, at random, one or more bags as necessary and submit as the sample.
Supplied as a stockpile	Follow the procedure from Section 4.2.

5. ARCHIVED VERSIONS

5.1 Archived versions are available.

Test Procedure for**RANDOM SELECTION OF BITUMINOUS MIXTURE
SAMPLES****TxDOT Designation: Tex-225-F****Effective Date: August 2016**

1. SCOPE

- 1.1 Use this test method to randomly select points from which to sample loose bituminous mixtures at the plant and to determine roadway locations for obtaining hot-mix asphalt cores.
 - 1.1.1 Use Part I to select sampling points of hot-mix asphalt mixtures and other materials randomly.
 - 1.1.2 Use Part II to select pavement locations for the coring of hot-mix asphalt pavements.
- 1.2 Use the automated [Random Number worksheet](#) to generate and report all results.
- 1.3 The values given in parentheses (if provided) are not standard and may not be exact mathematical conversions. Use each system of units separately. Combining values from the two systems may result in nonconformance with the standard.

PART I—RANDOM SELECTION OF PRODUCTION SAMPLES

2. SCOPE

- 2.1 Use this method to randomly select sampling points of hot-mix asphalt mixtures during plant production.

3. PROCEDURE

- 3.1 Select the lot and subplot size as defined in the specification.
- 3.2 Use the Random Number worksheet to determine the random numbers for production sampling for the entire project.

Note 1—Random numbers must be a decimal unit between 0.001 through 0.999. The random number is A in Table 1.
- 3.3 Multiply the total mass of the subplot as determined in Section 3.1 by the random number (A) determined in Section 3.2.

- 3.4 Add the result from Section 3.3 to the mass at the beginning of the subplot to obtain the mass for the sampling location.

Note 2—This is the Production Location, as shown in Table 1.

4. PRODUCTION SAMPLES EXAMPLE

- 4.1 Lot size = 2,000 tons (1814 Mg)

- 4.2 Sublot size = 500 tons (454 Mg)

Table 1—Production Samples Example

Sample	Sublot Mass	Random Number (A)	Sublot Location	Production Location
1	500 tons (454 Mg)	.515	258 tons (234 Mg)	258 tons (234 Mg)
2	500 tons (454 Mg)	.969	485 tons (440 Mg)	985 tons (894 Mg)
3	500 tons (454 Mg)	.532	266 tons (241 Mg)	1,266 tons (1149 Mg)
4	500 tons (454 Mg)	.709	355 tons (322 Mg)	1,855 tons (1684 Mg)

PART II—RANDOM SELECTION OF PAVEMENT LOCATIONS

5. SCOPE

- 5.1 Use this method to randomly select pavement locations for the coring of hot-mix asphalt pavements.

6. PROCEDURE

- 6.1 Determine the length and width of the subplot, after the subplot is completed.
- 6.2 Use the Random Number worksheet to determine the random numbers for the subplot length and width offset for the entire project.
Note 3—Random numbers must be a decimal unit between 0.001 through 0.999. The random numbers are A and B in Table 2.
- 6.3 Multiply the total length of the subplot by the subplot length random number (A) determined in Section 6.2, as shown in Table 2.
- 6.4 Add the result from Section 6.3 to the station number at the beginning of the subplot to obtain the station of the coring location.
Note 4—Make appropriate adjustments if the stationing is not continuous.
- 6.5 Multiply the width of the subplot by the subplot width offset random number (B) determined in Section 6.2, as shown in Table 2.

- 6.6 Measure the width offset from the right side of the subplot completed facing in the direction of paving.
Note 5—Adjust the subplot width location by no more than necessary, if the subplot width offset is within 2 ft. of a longitudinal joint or pavement edge.
- 6.7 Repeat Sections 6.3 through 6.6 to determine a new core location.

7. PAVEMENT CORE LOCATION EXAMPLE

- 7.1 Beginning Station = 0 + 00 ft. (0 + 000.000 m)
- 7.2 Lot size = 6,562 ft. (2000 m)
- 7.3 Sublot size = 1,640 ft. (500 m)

Table 2—Pavement Coring Location Example

Sample	Sublot Length	Random Number (A)	Sublot Location	Station Number	Sublot Width	Random Number (B)	Width Offset
1	1,640 ft. (500 m)	.035	57.4 ft. (17.5 m)	0 + 57.4 ft. (0 + 17.5 m)	12 ft (3.66 m)	.175	2.1 ft. (0.64 m)
2	1,640 ft. (500 m)	.392	642.9 ft. (196 m)	22 + 82.9 ft. (6 + 96.0 m)	12 ft (3.66 m)	.694	8.3 ft. (2.53 m)
3	1,640 ft. (500 m)	.970	1,590.8 ft. (485 m)	48 + 70.8 ft. (14 + 85.0 m)	12 ft (3.66 m)	.692	8.3 ft. (2.53 m)
4	1,640 ft. (500 m)	.932	1,528.5 ft. (466 m)	64 + 48.5 ft. (19 + 66.0 m)	12 ft (3.66 m)	.206	2.5 ft. (0.75 m)

8. ARCHIVED VERSIONS

- 8.1 Archived versions are available.

Tex-225-F, Random Selection of Pavement Locations



Lot Length (ft.) = 5213.4
 Beginning Station = 23 + 99.7

Sublot	Sublot Length	Random Number	Sublot Location	Station Number	Sublot Width	Random Number	Width Offset
1	1323.8	0.484			9.0	0.500	
2	1299.4	0.827			9.5	0.299	
3	1286.8	0.677			8.2	0.044	
4	1303.4	0.390			9.7	0.876	

--	--	--	--

Test Procedure for**THERMAL PROFILE OF HOT MIX ASPHALT**TxDOT Designation: **Tex-244-F****Effective Date: December 2015**

1. SCOPE

- 1.1 Use this test method to obtain a thermal profile that identifies the presence of thermal segregation of an uncompacted mat of hot mix asphalt. This method includes procedures for determining thermal profile using:
- a hand-held thermal camera immediately behind the paver during uninterrupted paving operations, or
 - a paver-mounted thermal imaging system.
- 1.2 The values given in parentheses (if provided) are not standard and may not be exact mathematical conversions. Use each system of units separately. Combining values from the two systems may result in nonconformance with the standard.
-

2. APPARATUS

- 2.1 *Thermal camera or thermal imaging system.*
- 2.1.1 Hand-held thermal camera must be capable of:
- measuring from 40°F to 475°F with an accuracy of $\pm 4^\circ\text{F}$ or $\pm 2\%$ of reading, whichever is greater;
 - producing an IR image minimum resolution of 19,200 pixels;
 - displaying the maximum temperature and minimum temperature using a LCD viewing screen with a minimum diagonal dimension of 3.0 in.;
 - storing a minimum of 50 images and capable of opening images while in operation;
 - a thermal sensitivity less than 0.15°F ; and
 - a variable emissivity from 0.1 to 1.0.
- 2.1.2 Paver-mounted thermal imaging system must be capable of:
- measuring at a maximum transverse spacing of 12 ± 1 in.;
 - using infrared sensors to measure from 40–475°F with an accuracy of $\pm 3.5^\circ\text{F}$ or $\pm 1.5\%$ of reading, whichever is greater, when the object temperature exceeds 32°F and the ambient temperature is $73 \pm 9^\circ\text{F}$;
-

- having temperature measurement repeatability of $\pm 1.8^{\circ}\text{F}$ or $\pm 0.75\%$ of reading, whichever is greater;
- measuring spots with a maximum size of 10 in. at the installed operating height;
- profiling the entire pavement width, up to at least 12 ft. wide, with provisions to prevent areas within 2 ft. of the edge of the uncompacted mat from influencing the thermal profile results;
- measuring distance using a Distance Measuring Instrument (DMI) and equipped with a Global Positioning System (GPS);
- collecting, displaying, saving, and analyzing temperature readings while in operation, using the latest software available;
- determining the low and high temperatures within each profile using the statistical 1 percentile and 98.5 percentile, respectively;
- producing output files of pavement temperatures for each day's placement and daily summary output files in an approved test report that identifies locations of thermal segregation with a recording of the temperature at such locations;
- providing software capable of developing and analyzing thermal profiles for the entire project; and
- providing an operating system with at least one USB port to save test results to a portable USB memory device.

3. REPORT FORMS

- 3.1 [Tx244-4.xlsm, "Thermal Profile of Hot Mix Asphalt \(4 Sublots Included\)."](#)
-

4. PROCEDURE

- 4.1 Operate the thermal imaging camera or thermal imaging system in accordance with the manufacturer's recommendations.
- 4.2 Obtain a new maximum baseline temperature and minimum profile temperature for every thermal profile measured.
- 4.3 Record the beginning and ending station numbers of all thermal profiles.
Note 1—Instead of station numbers, use of GPS coordinates or other approved means of identifying the locations is acceptable.
- 4.4 Obtain all temperature measurements in units of degrees Fahrenheit.
- 4.5 Obtain all temperature measurements while the paver is moving.
- 4.6 If the paver stops for more than 60 sec., exclude the area 2 ft. behind and 8 ft. in front (in the direction of travel) of the last temperature measurement.

- 4.7 Proceed to Section 4.8 when using a thermal imaging camera. Proceed to Section 4.9 when using a thermal imaging system.
- 4.8 *Using the Thermal Camera:*
- 4.8.1 Mark the pavement edge at the beginning and ending location of each thermal profile using spray paint or a permanent marker. Refer to Figure 1.

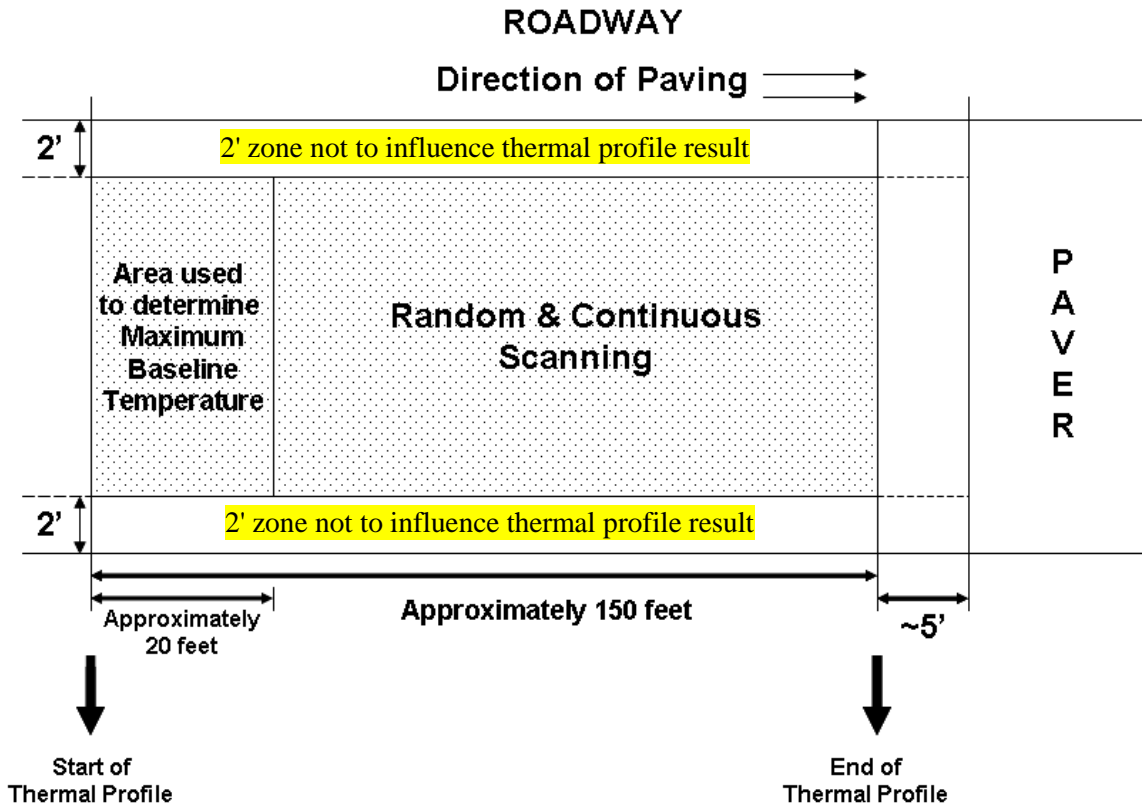

Figure 1—Thermal Profile when Using a Handheld Thermal Camera

- 4.8.2 Configure the thermal camera to achieve the optimum brightness and contrast of the display image and to adjust the minimum and maximum temperature levels automatically while performing thermal profiles. Do not manually enter the minimum and maximum temperature levels.
Note 2—Thermal cameras are generally equipped with an auto-adjusting feature, which automatically adjusts the minimum and maximum temperature levels, brightness, and contrast.
- 4.8.3 Observe the paving operations to determine the approximate distance the paver travels until the roller compacts the mat.
- 4.8.4 Determine the maximum baseline temperature over a paving distance of approximately 20 ft. (6.1 m).

Note 3—Each thermal profile will be approximately 150 ft. This distance includes the 20 ft. used to establish the maximum baseline temperature when profiling with a thermal imaging camera.

- 4.8.4.1 Stand at the edge of the uncompacted mat at a distance of approximately 5 ft. behind the paver, or stand on the paver screed.

Note 4—Follow all safety precautions and guidelines when standing on the paver screed.

- 4.8.4.2 Determine the lowest allowable profile temperature by subtracting 25°F from the maximum baseline temperature measured in Section 4.8.4.

- 4.8.5 Measure the temperature of the uncompacted mat in a zone approximately 5–15 feet behind the paver by pointing the thermal camera and squeezing the trigger. Avoid taking temperature measurements within 2 ft. of the edge of the uncompacted mat.

Note 5—When standing on the paver screed, refer to the manufacturer’s instructions for determining the relationship between the field of view and distance to determine the proper zone for evaluation within the thermal camera’s image. When standing at the edge of the uncompacted mat, pointing the thermal camera at a 90-degree angle to the direction of paving can ensure temperature data collected is within the required zone behind the paver.

Note 6—Avoid measuring high temperature areas caused by heating from the screed while the paver is stopped.

- 4.8.5.1 Save the image to the memory of the thermal camera.

Note 7—Additional images will be necessary to evaluate the total paving distance.

- 4.8.6 Following Section 4.8.5, determine the lowest temperature measured throughout the thermal profile over a paving distance of approximately 130 ft. Designate this as minimum profile temperature.

- 4.8.7 Record the low temperature obtained in Section 4.8.6, using spray paint or a permanent marker at the edge of the paving lane to indicate any area of the mat in which the profile is less than the lowest allowable profile temperature established in Section 4.8.4.2.

- 4.8.8 Record the station number to identify the location of the mat for the low temperature measured in Section 4.8.6.

Note 8—Instead of station numbers, GPS coordinates or other acceptable means may be used to identify the location.

- 4.8.9 Proceed to Section 5.1.

- 4.9 *Using the Thermal Imaging System:*

- 4.9.1 Refer to the summary output file for locations when using the thermal imaging system. Refer to Figure 2.

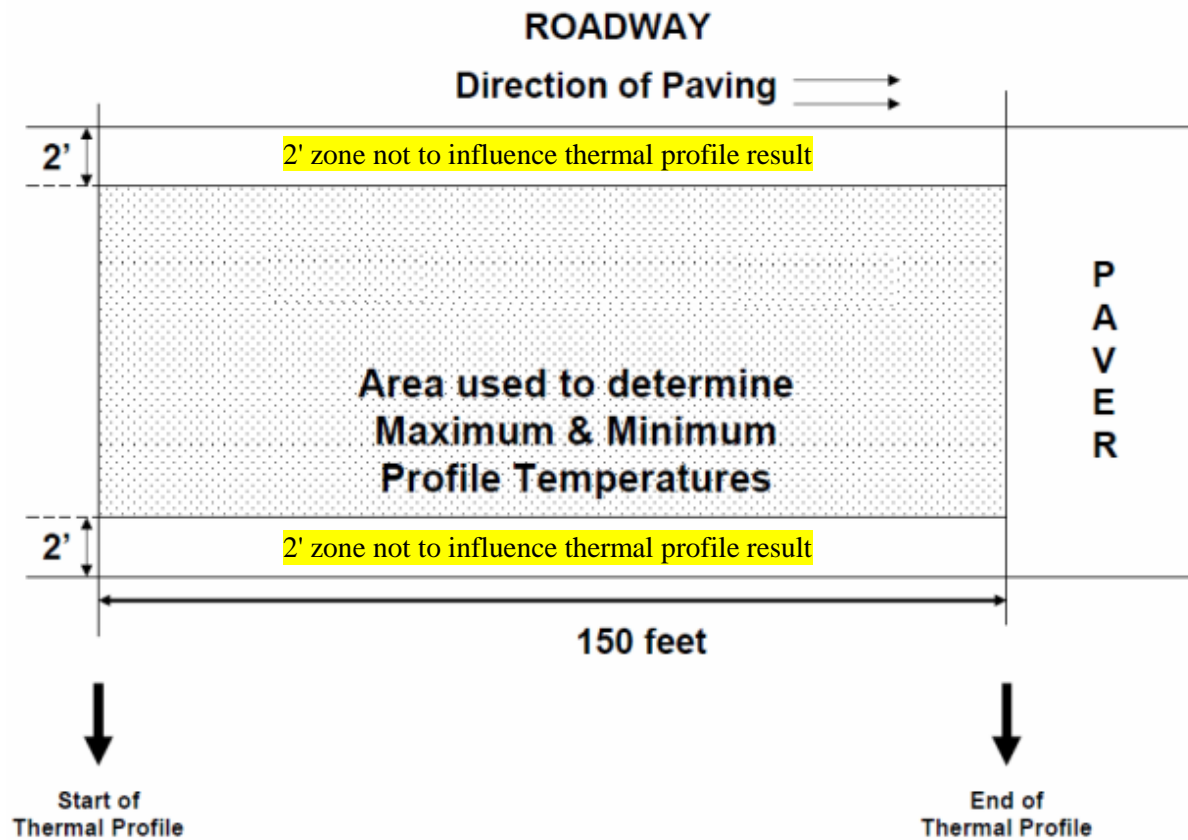

Figure 2—Thermal Profile when Using a Thermal Imaging System

- 4.9.2 Obtain the maximum baseline temperature when using the thermal imaging system by analyzing the temperature readings recorded throughout the entire 150-ft. length.
- 4.9.3 Install and operate the thermal imaging system on the paver following the manufacturer’s recommendations.
- 4.9.4 Verify the calibration for each temperature sensor prior to collecting temperature measurements per manufacturer’s recommendations.
Note 9—Check calibration of each temperature sensor to a known standard on an annual basis and recalibrate if necessary. Document the yearly check/calibration result.
- 4.9.5 Configure the thermal imaging system to record pavement temperatures at increments of no more than 12 in. of forward movement.
- 4.9.6 Generate the automated test report produced by the thermal imaging system from the temperature readings measured in Section 4.9.4.
Note 10—The test report must include the temperatures and locations (station numbers, GPS coordinates, or other acceptable means) where moderate or severe thermal segregation exists.
- 4.9.7 Proceed to Section 5.2.

5. CALCULATIONS

- 5.1 Calculate and record the temperature differential of the uncompacted mat surface when using a thermal camera:

Temperature Differential = Maximum Baseline Temperature - Minimum Profile Temperature

Note 11—Designate the Temperature Differential as having no thermal segregation, moderate thermal segregation, or severe thermal segregation.

- 5.2 Calculate and record the temperature differential of the uncompacted mat surface when using a thermal imaging system:

Temperature Differential = Maximum Temperature Recorded - Minimum Temperature Recorded

Note 12—The minimum and maximum temperatures within each profile are determined using the statistical 1 percentile and 98.5 percentile, respectively

6. ARCHIVED VERSIONS

- 6.1 Archived versions are available.

Thermal Camera Guidance Document

How to Conduct a Thermal Profile:

1. Begin by turning the thermal camera on by pressing the on/off button. Allow the camera to remain on a minimum of 5 minutes before beginning the thermal profile. If the tilde sign “~” is observed before the temperature reading in the top left corner of the screen, the camera has not had enough time to warm up. Open the shutter by sliding the lever above the trigger. Press the navigation pad. Select the settings icon and then press the navigation pad. Select measurement parameters and press the navigation pad. Adjust the measurement parameters such that the emissivity is 1.00, the reflected temperature is 68 °F, and the distance is 10 feet. The emissivity can be adjusted to 1.00 under the custom value setting. Return to the live image by pressing the cancel button twice. Adjust the language, time, and units by pressing the navigation pad. Select the settings icon and then press the navigation pad. Select device settings and press the navigation pad. Select language, time, and units and press the navigation pad. Adjust the language to English, the temperature unit to °F, the distance unit to feet, and enter the correct date and time. Return to the live image by pressing the cancel button three times. Adjust the image mode by pressing the navigation pad. Select the image mode icon and press the navigation pad. Select the Thermal MSX icon and press the navigation pad. Adjust the color by pressing the navigation pad. Select color and press the navigation pad. Select rainbow and press the navigation pad. Charge the camera as needed using the charger provided. A diagram of the camera showing the main functions is given in Figure 1.
Note – Do not point the camera at the sun; direct exposure can affect the accuracy and damage the detector.

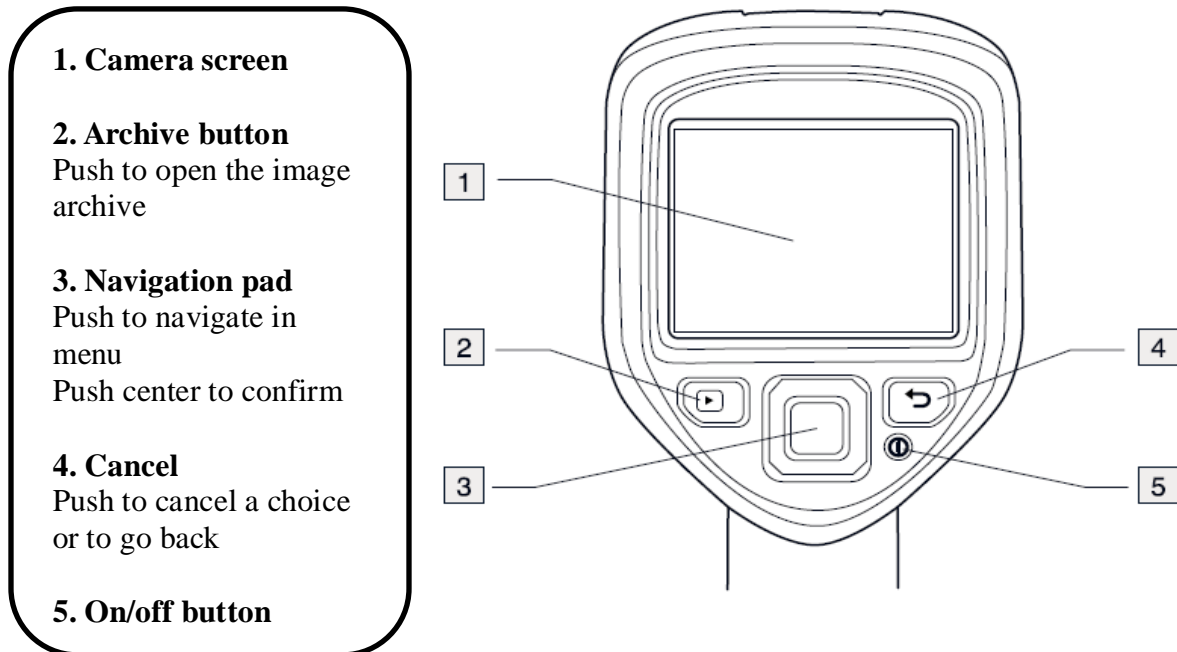

Figure 1. Main Functions of the Thermal Camera

- It is recommended that the pavement edge is marked according to the marker numbers discussed below, before the paver has paved the pavement (marks are placed ahead of the paver) as shown in Figure 2:

Marker Numbers (MN)

- MN1** – identifies beginning of thermal profile (record station number as beginning)
- MN2** – at a distance of 20 feet from Marker Number 1
- MN3** – at a distance of 150 feet from Marker Number 1 (record station number as ending)

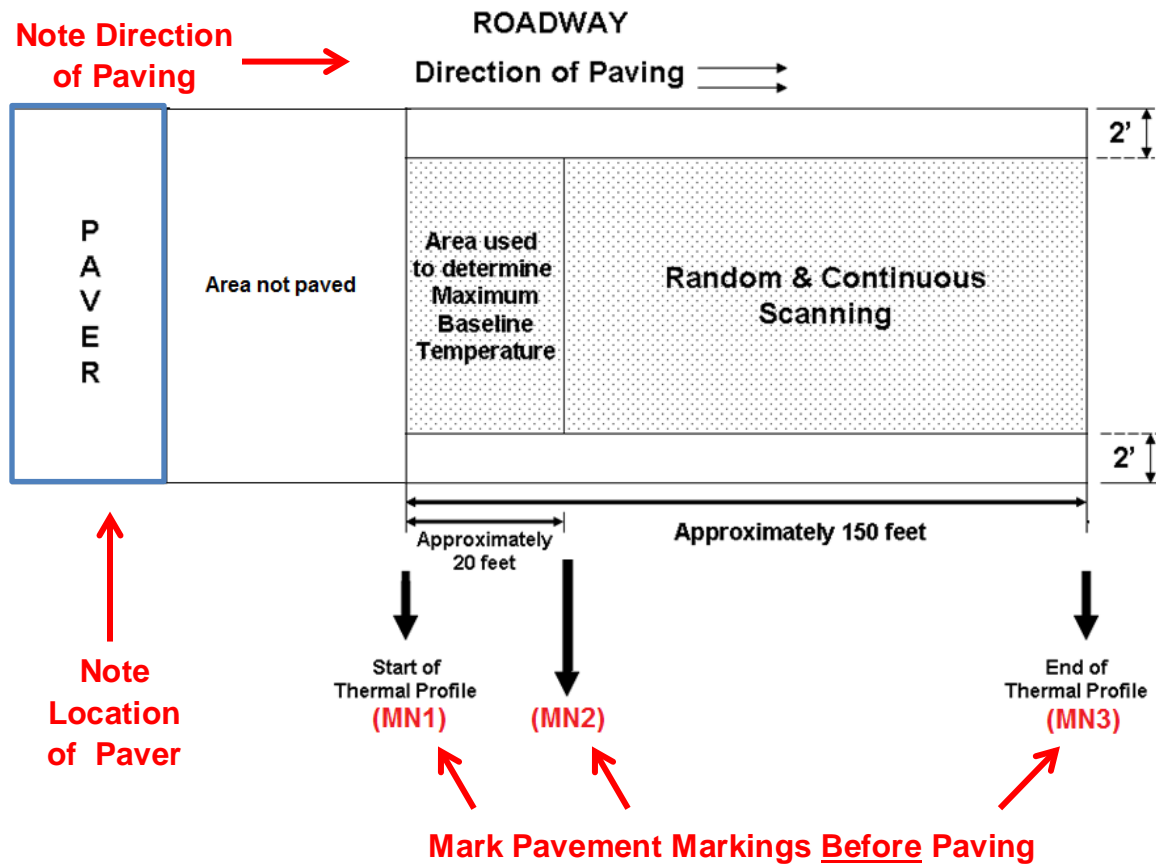

Figure 2. Marker Number Locations Ahead of the Paver

- Record the beginning and ending station numbers of all thermal profiles. The total length of the temperature profile is approximately 150 feet unless the paver stops for more than 60 seconds.
 Note – If the paver stops for more than 60 seconds, exclude the area 2 feet behind and 8 feet in front of the paver (in the direction of travel) from the thermal profile. This distance needs to be added to the length of the overall temperature profile length. For example, if the paver stops once during the profile, for more than 60 seconds, the length of the thermal profile is increased from 150 feet to 160 feet.

4. Return to the location of MN1. Press the navigation pad. Select the measurement icon and press the navigation pad. Select hot spot and press the navigation pad. Refer to Figure 1 for a description of the main functions.
5. As soon as the paver passes MN1, place a piece of wood (measuring 2 feet in length with a string attached) with one end on the near edge of the pavement and the other extending on the pavement surface. The purpose of using the 2' piece of wood is to provide a reference point to exclude taking temperature measurements within 2 feet of the near edge of the uncompacted mat. The piece of wood should have a string attached to one end, so it can be removed when standing several feet away from the pavement edge. The wood should be placed in line with the pavement marker identifying the location of MN1. Refer to the photograph in Figure 3.

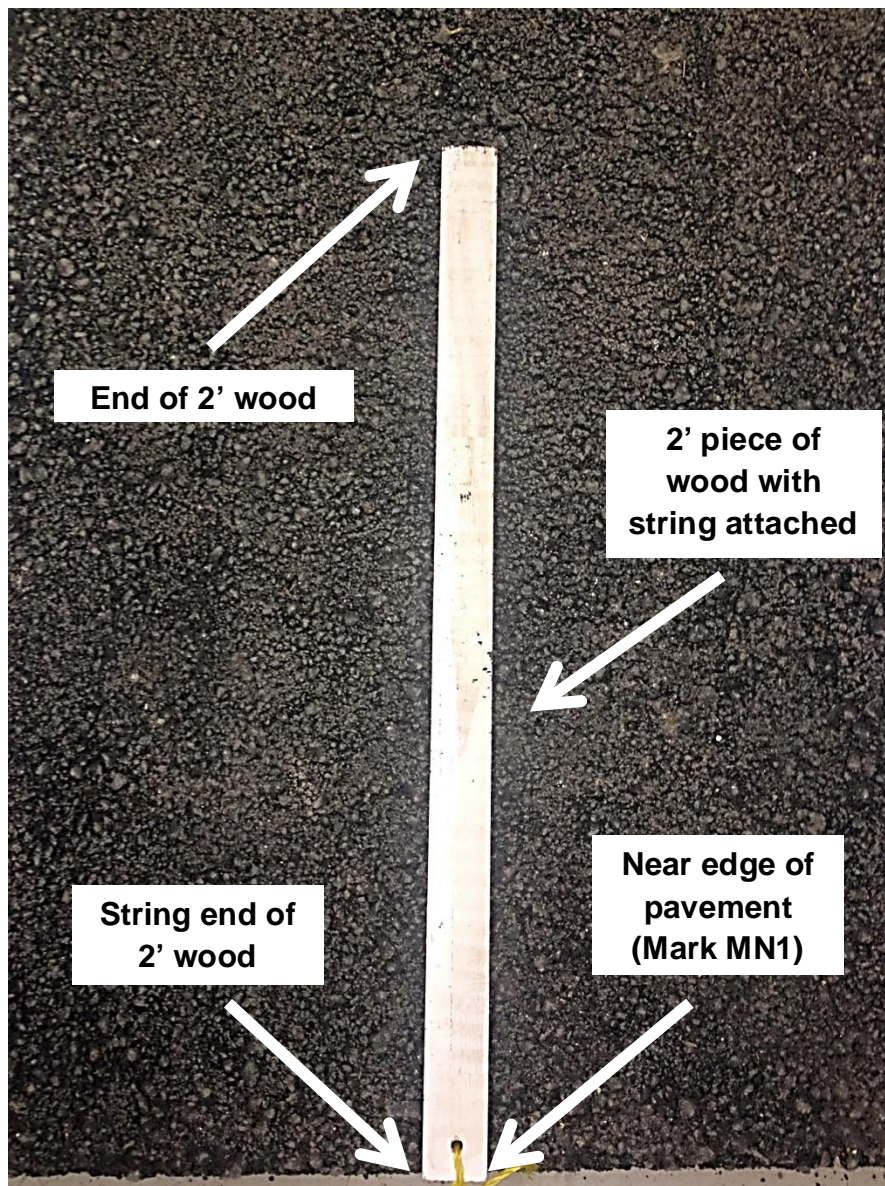

Figure 3. Location of 2' Piece of Wood with String on Pavement Surface

6. Hold the camera in hand with your elbow next to your side. Your arm should be bent approximately 135° and your feet and body should be pointed parallel to the pavement near edge. Hold the end of the string in the other hand. Locate the end of the wood on the bottom of the screen on the thermal camera image as shown in Figure 4. Move towards or away from the pavement near edge and adjust the angle of your arm until the far edge of the pavement and the end of the wood is visible in the image as shown in Figure 4. Hold the camera at an angle that is comfortable and position the camera close enough to be able to read the temperature in the top left corner on the screen. You should be approximately 3-4 feet from the pavement near edge. Refer to the photograph in Figure 5 below for the proper orientation.

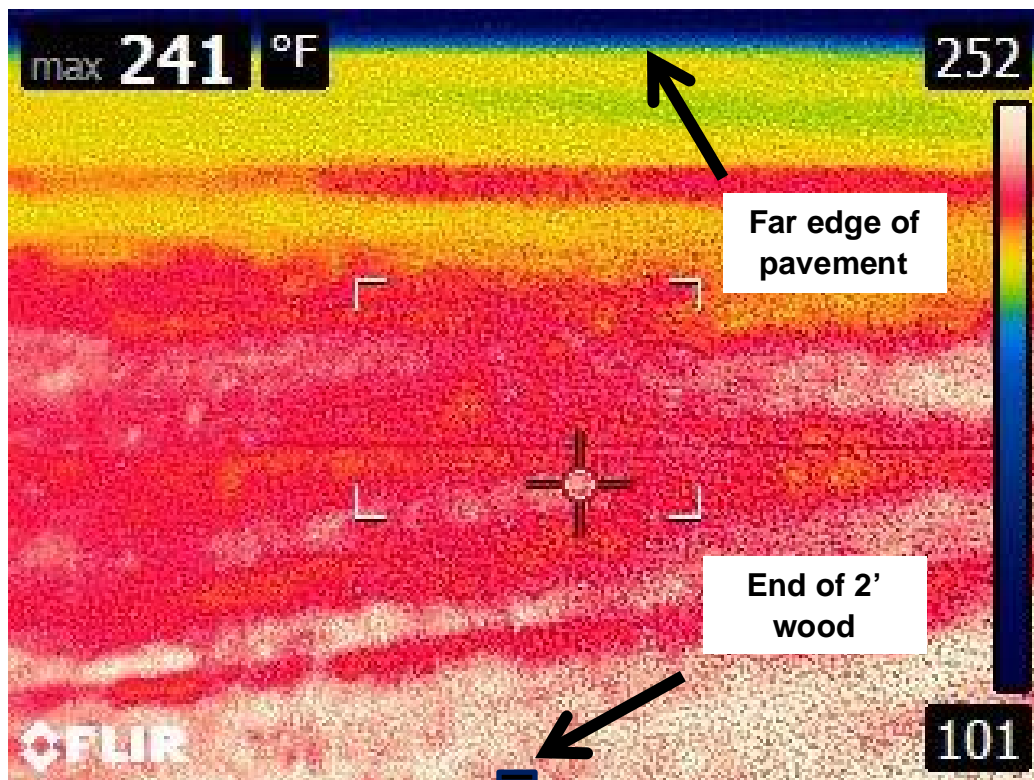

Figure 4. Thermal Image Showing the End of 2' Wood and the Far Edge of the Pavement

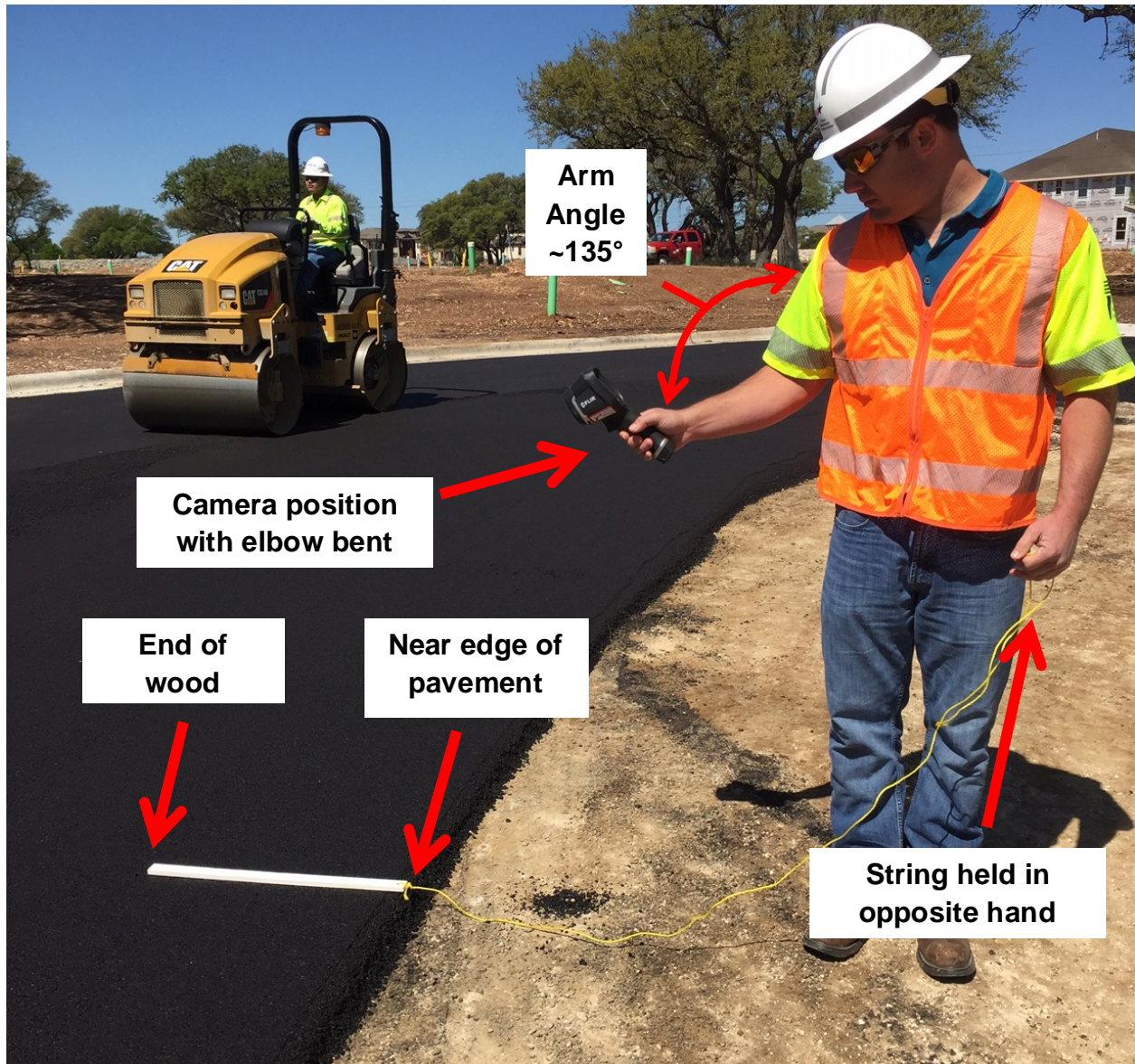

Figure 5. Photograph Illustrating the Proper Orientation of the Person Performing the Thermal Profile

7. Once the far edge of the pavement and the end of the wood is observed on the thermal camera screen, make note of the distance between you and the near edge of the pavement (approximately 3-4 feet). Also make note of the clearance between the far edge of the pavement and the top of the screen on the thermal camera screen as shown in the thermal image in Figure 6. Throughout the thermal profile, keep the same distance between you and the near edge of the pavement with the same arm angle, while also maintaining the clearance shown in Figure 6.
Note – The temperature scale on the right hand side of the thermal image is not used for conducting the thermal profile. Only the temperature recorded in the top left corner of the thermal image is used for the thermal profile.

Note – The temperature icon in the top left corner of the screen can be used as a guide to establish the clearance. For example in Figure 6, the far edge of the pavement is visible in the thermal image because of the distinct blue color associated with the low temperature. In Figure 6, the far edge of the pavement lines up with the degrees (°) symbol. It is recommended that the clearance as shown in Figure 6 is minimized to ensure the middle of the pavement is analyzed. The far edge of the pavement as shown in Figure 6 should not extend below the black boxes surrounding the temperature and unit of measurement (black boxes surrounding “max 241” and °F).

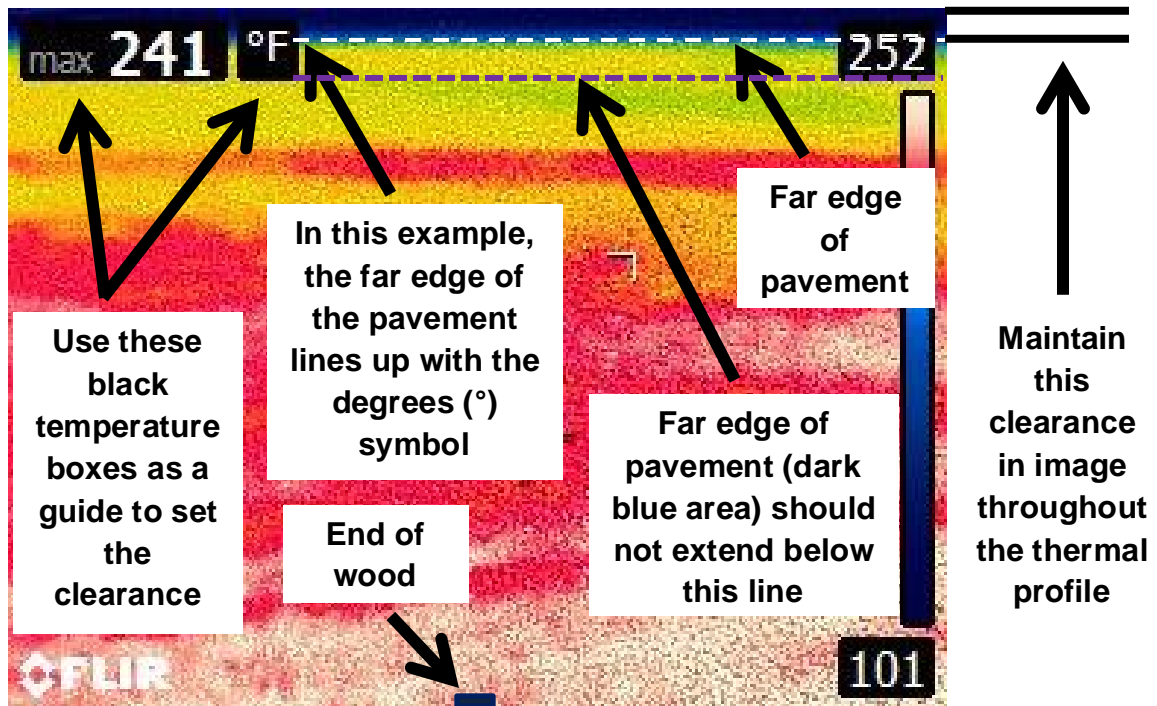

Figure 6. Thermal Image Demonstrating the Clearance Between the Far Edge of the Pavement and the Top of the Screen on the Image of the Thermal Camera

8. Remove the wood from the pavement by pulling the string. Do not move away from the pavement near edge during this process. If the angle of the camera changed, reset the angle by closely matching the same clearance between the far edge of the pavement and the top of the screen on the thermal camera as shown in Figure 6.
9. Walk approximately 5 feet behind the paver at the same speed of the paver. Keep the same distance from the near edge of the pavement by walking parallel with the pavement near edge. With the same arm angle and clearance between the far edge of the pavement and the top of the screen, establish the maximum baseline temperature by recording the maximum temperature observed in the top left corner of the screen from the area between pavement markings MN1 and MN2. For documentation purposes, take at least 2 to 3 photos throughout this section by pulling the trigger on the camera.

Note – The temperature shown in the top left corner of the screen is measured within the four angles as illustrated in the box drawn on the thermal image in Figure 7. When the same arm angle, clearance between the far edge of the pavement and the top of the screen, and distance away from the pavement near edge is maintained, the box in which the temperature is measured should be near the middle of the pavement.

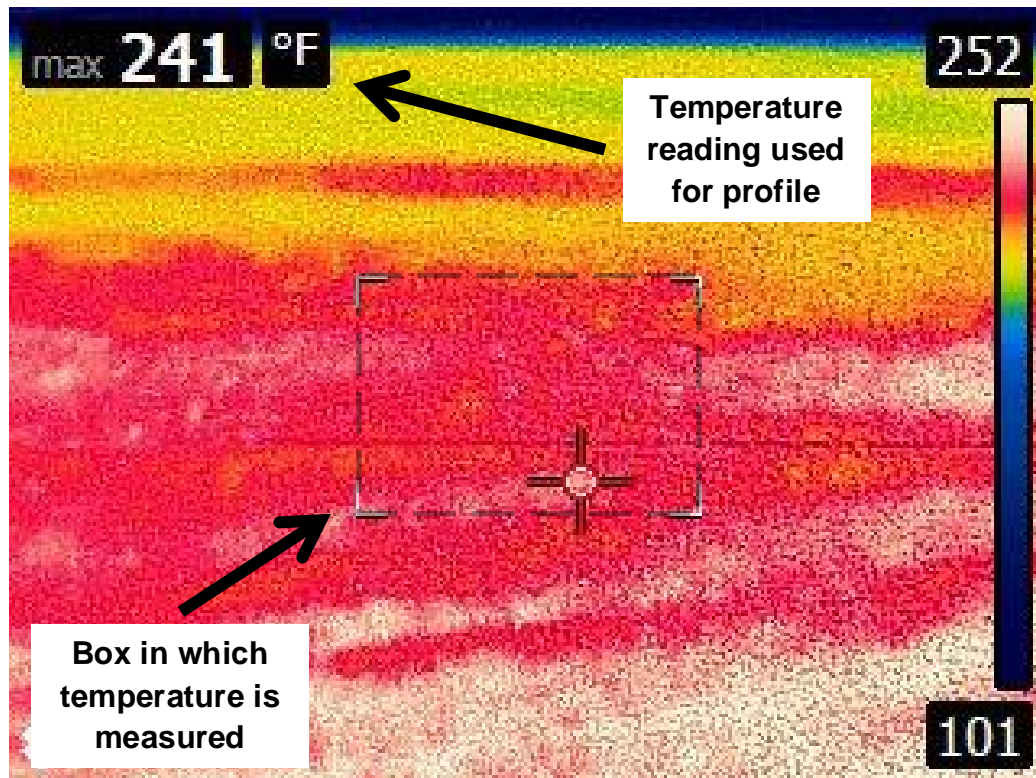

Figure 7. Thermal Image Illustrating the Box in which the Temperature is Measured by the Thermal Camera

Note – Thermal segregation may be observed during the establishment of the maximum baseline temperature. Thermal segregation should appear as an abrupt color change from white/red/yellow to green/blue. Refer to 16) and 17) for the definition of thermal segregation. If an abrupt color change is observed during the establishment of the maximum baseline temperature on the pavement, press the navigation pad button and select the measurement icon. Press the navigation pad and select cold spot. Press the navigation pad. Angle the camera such that box includes the area where the thermal segregation is observed. Take pictures by pulling the trigger on the camera. If thermal segregation is confirmed, refer to 12). An example of the appearance of thermal segregation is given in the thermal image in Figure 8. The cause of the thermal segregation in this case was the result of the steel roller after the screed, and thus was not regarded as moderate or severe thermal segregation.

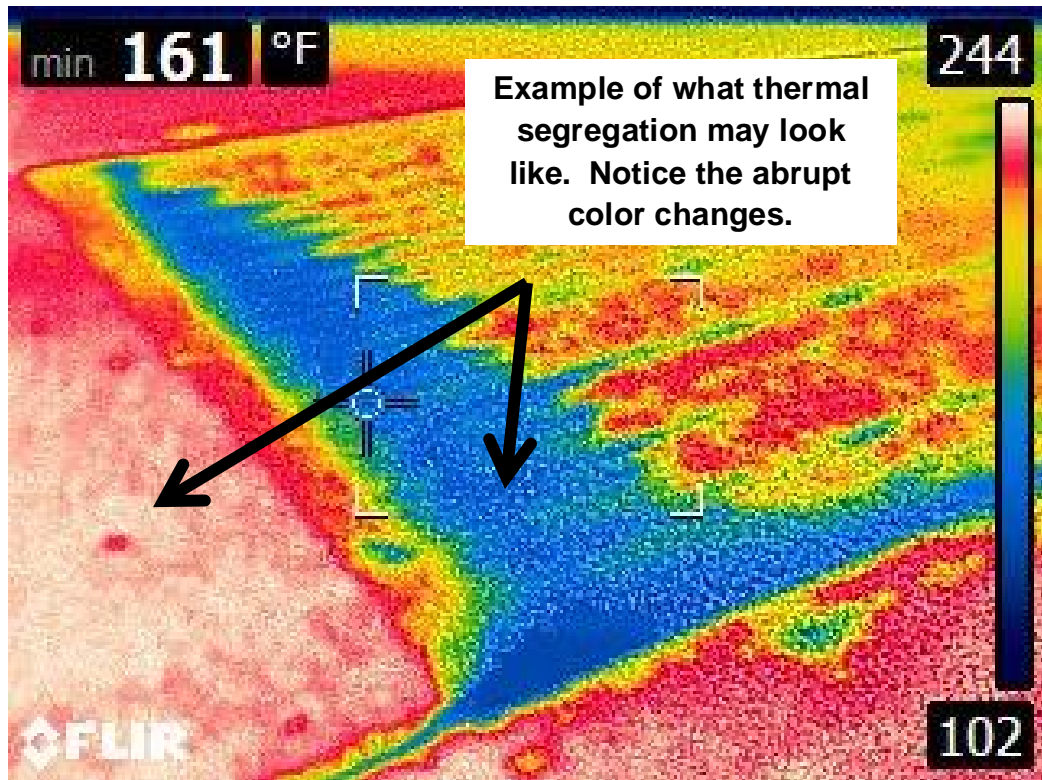

Figure 8. Example of the Appearance of Thermal Segregation

10. As soon as you approach the mark identifying the location of MN2, press the navigation pad. Select the measurement icon and press the navigation pad. Select cold spot and press the navigation pad. Refer to Figure 1 for a description of the main functions. Determine the lowest allowable profile temperature by subtracting 25 °F from the maximum baseline temperature determined between markings MN1 and MN2. This temperature is the minimum profile temperature.
11. Continue walking behind the paver at the same speed and at a distance of approximately 5 feet. Maintain the same distance away from the near edge of the pavement. Maintain the same arm angle and clearance between the far edge of the pavement and the top of the thermal camera screen as observed in Figure 6. Observe the temperatures in the top left corner of the screen looking for temperatures below the minimum profile temperature. Take pictures by pulling the trigger on the camera. It is recommended that at least 13 to 15 pictures are taken between the markings MN2 and MN3.
 Note – As previously discussed, the temperature shown in the top left corner of the screen is measured within the four angles as illustrated in the box drawn on the thermal image in Figure 7. During the thermal profile, also observe if any abrupt color changes (from white/red/yellow to green/blue) are observed outside of this box on the pavement. If an abrupt color change is observed outside of the box, angle the camera such that the box includes the area where the abrupt color change is observed. Take pictures by pulling the trigger on the camera. If thermal segregation is confirmed, refer to 12).

12. If the minimum temperature observed is less than the minimum profile temperature, mark the near edge of the pavement or any areas of the mat using spray paint. Record the temperature differential to identify the type of thermal segregation (moderate or severe) and the station number to identify the location on the mat where the thermal segregation was observed. Take pictures by pulling the trigger on the camera.
13. If you need to move away from the pavement for any reason, reset the distance between you and the pavement by using the piece of wood and the method previously discussed.
14. As stated before, the area 2 feet behind and 8 feet in front of the paver (in the direction of travel) is excluded from the thermal profile if the paver stops for more than 60 seconds. However, the thermal camera can be used to ensure the screed heaters do not overheat the mat as shown in the thermal image in Figure 9. Turn off the screed heaters as needed to prevent overheating of the mat.
Note – Further testing according to the specification including the aging ratio may be required if the Engineer suspects the area has experienced overheating. Mark the areas in question and record the station number. Take pictures as necessary for documentation.

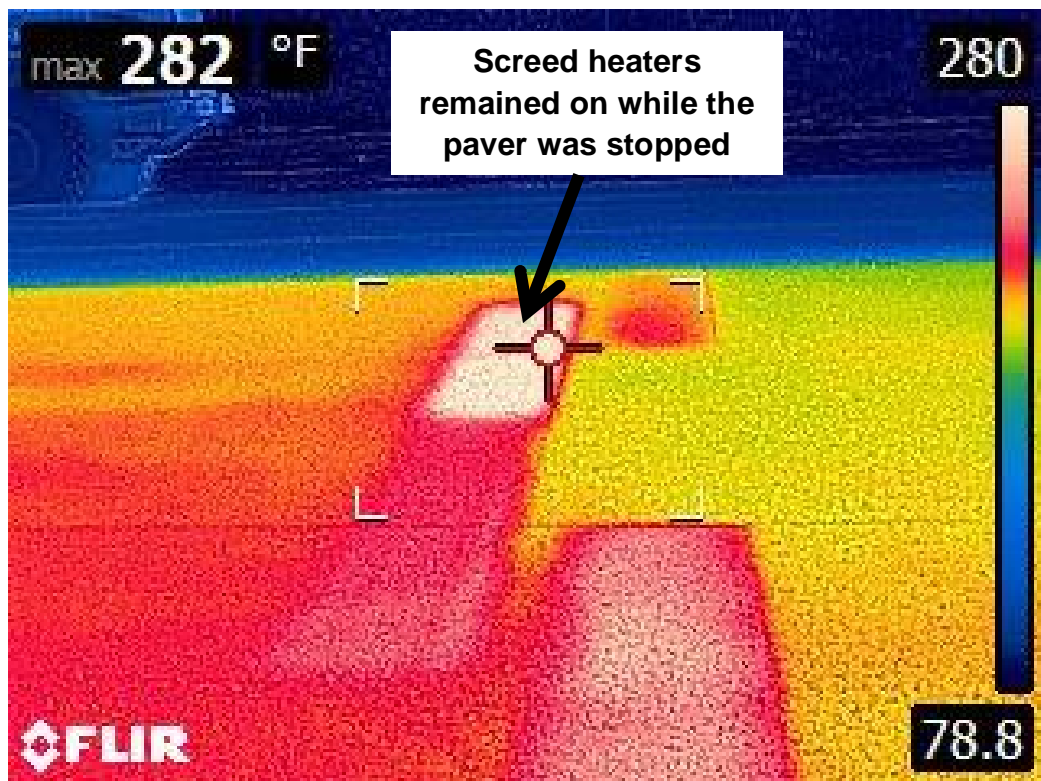

Figure 9. Example of Screed Heaters Remaining On While Paver was Stopped

15. Continue the thermal profile until reaching the marking MN3. After completion of the thermal profile, close the shutter to protect the lens.
Note – If the paver stopped for more than 60 seconds, an additional 10 feet needs to be added to the length of the thermal profile for each stop.

16. If areas with recurring moderate thermal segregation (25.1 °F to 50.0 °F temperature differential between the maximum baseline temperature and the minimum profile temperature) are observed, take immediate corrective action and mark the locations. Perform a density profile in the marked area and record the station numbers.
17. If an area with severe thermal segregation (greater than 50.0 °F temperature differential between the maximum baseline temperature and the minimum profile temperature) is observed, suspend operations and take corrective action. Perform a density profile in the marked area and record the station number.
18. Provide the Engineer with the thermal profile and density profiles (if applicable) of every subplot within one working day of the completion of each lot. Report the results of each thermal profile in accordance with the section “Reporting and Responsibilities” as outlined in the specification.
19. The Engineer will use a hand-held thermal camera to obtain a thermal profile at least once per project.
20. Please contact the Flexible Pavements Branch of the Construction Division with any questions.

Test Procedure for**PERMEABILITY OR WATER FLOW OF HOT MIX ASPHALT**TxDOT Designation: **Tex-246-F**Effective Date: **May 2022**

1. SCOPE

- 1.1 Use this test procedure to evaluate the permeability of hot mix asphalt. Use of a cylindrical field permeameter measures permeability or water flow rate as water channels onto the pavement surface.
- 1.1.1 Use this test procedure on Permeable Friction Course (PFC) and Thin Bonded Friction Courses (TBFC) pavements, under construction or on roadways already constructed, to test and verify that the compacted mixture has adequate permeability. High permeability of PFC and TBFC mixtures is critical, as a primary purpose is to drain water off the pavement surface, to reduce splash and spray, and to improve the wet pavement friction to decrease hydroplaning.
- 1.1.2 Use this test procedure on Thin Overlay Mixtures (TOM) pavements, under construction or on roadways already constructed, to test and verify that the compacted mixture is impermeable. Low permeability of TOM mixtures is critical, as a primary purpose of TOM is to seal off the underlying pavement layers from moisture infiltration.
- 1.2 The values given in parentheses (if provided) are not standard and may not be exact mathematical conversions. Use each system of units separately. Combining values from the two systems may result in nonconformance with the standard.

2. APPARATUS

- 2.1 *Cylindrical field permeameter*, used to channel water onto the pavement surface, equipped with a pipette graduated in divisions of 1.0 in. (25mm). (See Figure 1.)
- 2.2 *Stopwatch or timing device*, used to record the time of travel of water in the pipette, graduated in divisions of 1.0 sec.
- 2.3 *Plumber's putty*, used to seal the field permeameter to the pavement surface.

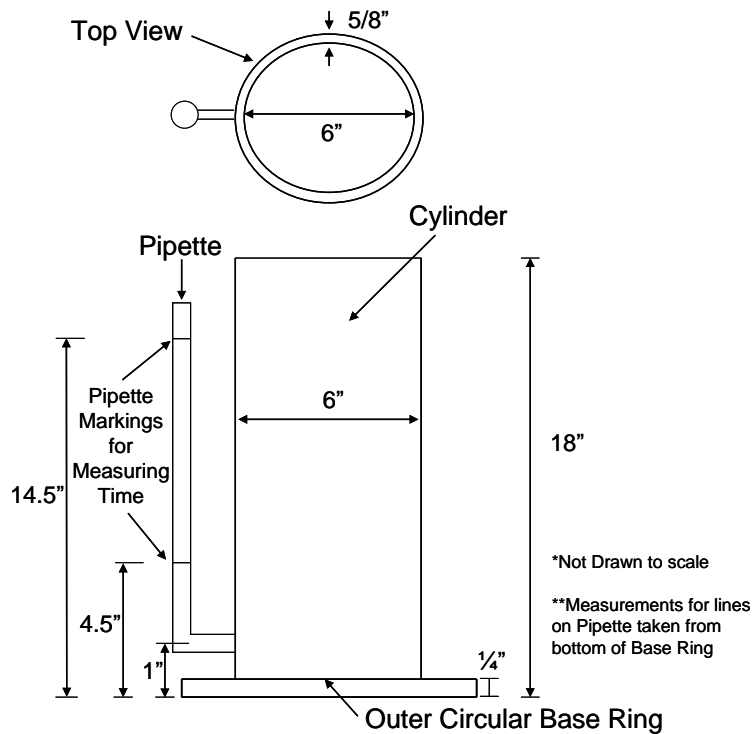

Figure 1—Field Permeameter Used to Measure Water Flow Rate

3. PROCEDURE

- 3.1 Select an area of the compacted hot mix asphalt pavement after it cools down immediately following roller compaction or of any roadway already constructed. Remove any debris on the pavement surface that can hinder the sealing of the permeameter to the surface of the mat.
- 3.2 Turn the permeameter upside down, so that the bottom of the outer circular base ring is facing upwards, and then place a ring of plumber's putty onto the surface of the outer circular base ring. Use an adequate amount to create a watertight seal between the permeameter and the pavement surface.
- 3.3 Turn the permeameter upside down and push it onto the pavement surface. Use enough force to create a watertight seal between the permeameter and the pavement surface, where the plumber's putty penetrates the surface voids of the pavement surface.
- 3.4 Trim and remove any excess plumber's putty inside the permeameter.
- 3.5 Push on the excess plumber's putty outside the permeameter with the use of a thumb or finger against the outer circular base ring to tighten the seal between the pavement surface and permeameter.
- 3.6 Fill the permeameter with water approximately 1–2 in. (25–50 mm) above the top marking on the pipette.
- 3.7 Start the timing device when the water level reaches the top marking on the pipette.
- 3.8 Stop the timing device when the water level reaches the bottom marking on the pipette.
- 3.9 Record the time the water traveled from the top marking on the pipette to the bottom marking on the pipette.

Note 1—Typical range is normally less than 20 sec. for newly constructed PFC mixtures.

4. ARCHIVED VERSIONS

4.1 Archived versions are available.

Test Procedure for**OBTAINING AND TRIMMING CORES OF
BITUMINOUS MIXTURES****TxDOT Designation: Tex-251-F****Effective Date: November 2019**

1. SCOPE

- 1.1 Use Part I of this test method to obtain cores drilled from compacted bituminous pavements.
 - 1.2 Use Part II of this test method to trim cores to prepare specimens for laboratory testing.
 - 1.3 The values given in parentheses (if provided) are not standard and may not be exact mathematical conversions. Use each system of units separately. Combining values from the two systems may result in nonconformance with the standard.
-

PART I—OBTAINING CORES OF BITUMINOUS MIXTURES

2. SCOPE

- 2.1 Use this procedure to obtain cores drilled from bituminous mixtures.
-

3. APPARATUS

- 3.1 *Core Bit*, of hardened steel or other suitable material, diamond-impregnated in cutting edge, of desired diameter.
 - 3.2 *Core Drill*, motor-driven with enough horsepower to obtain full-depth cylindrical cores.
 - 3.3 *Cooling Agent*, such as water, ice, or dry ice.
 - 3.4 *Retrieval Device*, for removing cores, such as a steel rod, thin wire loop, or mallet.
 - 3.5 *Security Bags*, Department-provided.
 - 3.6 *Repair material*, for filling in core holes.
-

4. PROCEDURE

- 4.1 Ensure the pavement surface is sufficiently cool to prevent damage to the core.
-

Note 1—A **maximum** surface temperature of 160°F is recommended to prevent damage to the core.

Note 2—A cooling agent can be used to decrease the surface temperature before coring.

- 4.2 Place the core bit directly above the desired sampling location.
- 4.3 Provide water to aid in the removal of cuttings and to minimize the generation of heat caused by friction between the core bit and the pavement.
- 4.4 Maintain the core bit perpendicular to the pavement while applying constant downward pressure on the core bit until the desired depth is achieved.
- Note 3**—Failure to apply constant pressure or applying excessive pressure may cause the core bit to bind or the core to distort.
- 4.5 Use retrieval device to take the pavement core out of the core bit. Avoid distorting, bending, or cracking the cores.
- 4.6 Place cores in security bags and store in a cool place.
- 4.7 Remove water from core hole.
- 4.8 Repair the resulting core hole by filling with approved patch material or hot mix and compacting until top is flush with the pavement surface.

PART II—TRIMMING CORES OF BITUMINOUS MIXTURES

5. SCOPE

- 5.1 Use this procedure to trim cores to prepare specimens for laboratory testing.

6. APPARATUS

- 6.1 *Masonry Saw*, for trimming ends of cores, with diamond or silicon-carbide cutting edge and capable of cutting cores without introducing cracks or dislodging aggregate particles.
- 6.2 *Marker*, such as paint pen or permanent marker.
- 6.3 *Measuring Device*, such as a ruler, calipers, or measuring tape.

7. PROCEDURE

- 7.1 For cores with uneven surfaces, follow the instructions in Sections 7.3–7.12.
- 7.2 For cores with level surfaces, measure the untrimmed core height to the nearest 1/16 in. and proceed to Section 7.8.
- Note 4**—When measuring the untrimmed core height, do not include foreign matter. Foreign matter is material extraneous to the pavement layer being tested; examples

- include another paving layer, such as hot mix, surface treatment, subgrade, or base material.
- 7.3 On the top surface of the core, mark the apparent thinnest location with a marker.
- 7.4 Make three more marks around the perimeter of the core at 90, 180, and 270 degrees from the mark made in Section 7.3.
- 7.5 Measure the height of the core at the marked locations. Refer to Note 4.
- 7.6 Take additional measurements around the core if the measurements taken in Section 7.5 vary by more than 1/4 in. Mark the location of the additional measurements.
- 7.7 Average the measurements and record the untrimmed core height to the nearest 1/16 in.
- 7.8 Remove visually evident foreign matter and tack material from the core with a saw or by any other satisfactory means.
- 7.9 Ensure that the sample size and number of samples conform to the requirements of Tex-222-F.
- 7.10 Trim the bottom or top of the core only when necessary. Remove any foreign matter and tack material to ensure a level and smooth surface for testing.
- 7.11 Trim the minimum amount of core necessary, but no more than 1/2 in.
Note 5—Do not trim the core if the surface is level and there is not foreign matter or tack material bonded to the surface of the core.
- 7.12 Measure and record the trimmed core height to the nearest 1/16 in.

Test Procedure for**SAMPLING BITUMINOUS MATERIALS, PRE-MOLDED JOINT FILLERS, AND JOINT SEALERS**TxDOT Designation: **Tex-500-C**Effective Date: **May 2020**

1. SCOPE

- 1.1 These procedures apply to the sampling of liquid, semi-solid, or solid bituminous materials at the point of manufacture, storage, and delivery. Sampling can be from tanks, containers, bulk storage, tank cars, distributors, drums, or cakes, for the following purposes:
- preliminary investigation of material source,
 - quality tests of bituminous materials at point of manufacture, and
 - inspection of materials at the site of the project.
- 1.2 The test method is in several parts, containing procedures for the following:
- Part I—Sampling from Storage Tanks;
 - Part II—Sampling from Pipelines;
 - Part III—Sampling from Tank Cars, Trucks, or Distributors;
 - Part IV—Sampling from In-line Blended Materials;
 - Part V—Sampling from Drums, Packages, or Cakes;
 - Part VI—Sampling Pre-Molded Expansion Joint Filler and Asphalt Plank;
 - Part VII—Sampling Joint Sealers;
 - Part VIII—Sampling Bituminous Marker Adhesive;
 - Part IX—Recording, Labeling, Packaging, Storing, and Shipping of Samples.
- 1.3 The values given in parentheses (if provided) are not standard and may not be exact mathematical conversions. Use each system of units separately. Combining values from the two systems may result in nonconformance with the standard.
- 1.4 This test procedure does not claim to cover all the required measures to address health and safety concerns. It is the responsibility of the sampler to take all the necessary precautions and follow any applicable health and safety procedures.
-

2. GENERAL PROCEDURES

- 2.1 Except as described in specific sections below, one can perform sampling in accordance with AASHTO R66 - "Standard Practice for Sampling Asphalt Materials."
- 2.2 Use appropriate safety precautions when sampling or handling liquid or semisolid materials.
-

- 2.2.1 Use, as a minimum, the following Personal Protective Equipment (PPE):
- gloves;
 - glasses, goggles, or face shield;
 - long sleeve shirt;
 - long pants; and
 - shoes that cover the entire foot.
- 2.2.2 For sampling liquid asphalts, open sample valves with caution; as asphalt materials in all types of containers may be under pressure.
- 2.3 Use appropriate containers with a capacity corresponding to the required amount of material for sampling:
- liquid asphalt, other than emulsions and cutbacks: double-seal friction-top metal cans, clean and dust-free, dry, with a minimum capacity of 1 qt. (1 L);
 - emulsified asphalt: wide-mouth plastic jars, clean and dust-free, dry, with a minimum capacity of 1 qt. (1 L);
 - cutback asphalt: double-seal friction-top or screw-top metal cans, clean and dust-free, dry, with a minimum capacity of 1 qt. (1 L);
 - solid or semisolid bituminous materials from drums, packages, or cakes: friction-lid bucket or can, clean and dust-free, dry, with a minimum capacity of 1 gal. (4 L);
 - pre-molded expansion joint filler and asphalt plank: box or light piece of plywood, clean and dust-free, dry, with a minimum base dimension of 12 x 12 in. (300 x 300 mm);
 - joint sealers: friction-lid bucket or can, clean and dust-free, dry, with a minimum capacity of 1 gal. (4 L); or
 - bituminous marker adhesive: sample boxes, clean and dust-free, dry, with a minimum capacity of 12 to 15 lb. (5.5 to 7 kg.).
- 2.4 Collect representative samples.
- 2.4.1 When sampling liquid asphalts other than emulsions, fill the container to approximately 95% capacity; leaving a small amount of space for stirring the sample before the tests. When sampling emulsions, completely fill the container to avoid any air entrapment in the sample.
- 2.4.2 Eliminate any possible source of contamination including but not limited to:
- remaining residual of other types and grades of asphalt in the tank or line being sampled;
 - presence of cleaning agents in the tank, line, or nozzle bar being sampled;
 - remaining residual of other types and grades of asphalt, cleaning agents, or any foreign matter on the sampling device; or
 - dust, moisture, fuel, or any foreign matter in the sampling container.
- 2.4.3 Avoid any alteration of the material being sampled by filtering or screening.

PART I—SAMPLING FROM STORAGE TANKS

3. SCOPE

- 3.1 Refineries and asphalt producers are required to store semi-solid asphalt, liquid asphalt, and emulsified asphalt in metal tanks provided with a number of drain cocks, depending on the capacity of the tank, located on the side at definite distances from the top.
- 3.2 Use the following procedure when sampling liquid bituminous materials from these storage tanks.
-

4. PROCEDURE

- 4.1 The number of samples collected per bulk storage tank mainly depends upon the capacity of the tank.
- 4.1.1 Take two samples, from 1/3 and 2/3 of tank depth, for tanks of up to 400,000 gal. (1,500,000 L) capacity.
- 4.1.2 Take three samples, from top, middle, and bottom of the tank, for tanks of more than 400,000 gal. (1,500,000 L) capacity.
- 4.1.3 If the tank contains a mechanism such as Mechanical Agitators or Circulators, to ensure uniformity of the material contained within it and observation or testing samples from various levels within the tank verifies the mechanism, a single sample is satisfactory for test purposes.
- 4.1.4 When collecting samples for submission to the Department, samples from multiple elevations on the tank are not required except by the Engineer's request. In this case, Department representatives may randomly choose at least one valve location for sampling.
- 4.2 Wearing the required safety equipment, collect the sample using either Valve or Thief or Dip Sampler method.
- 4.2.1 **Valve Method:** Open the appropriate valve or drain cock on the tank and allow enough material (a minimum of 1 gal or 4 L) to flow into a waste container to ensure a representative sample. Then, fill the sample container from the valve or drain cock. Figure 1 shows common types of valves used for sampling liquid asphalt from tanks.
- 4.2.2 **Thief or Dip Sampler Method:** Due to safety concerns, it is not recommended to take samples by Thief or Dip method from the top of the tank, unless no other method of sampling is available. If valves or drain cocks are not available, take samples by lowering a Thief Sampler or a weighted container (Dip method) into the tank.
- 4.2.2.1 **Thief Method:** This type of sampler contains a cylindrical tube with no top closure and a closing valve at the bottom. The sampler should be lowered to the tank with the bottom valve open. When the sampler reached to the desired depth, the bottom valve should be closed. Then the sample is gently pulled out and transferred to a container. Figure 2 shows an acceptable type of Thief sampler.
- 4.2.2.2 **Dip Method:** The container should be fitted with a stopper, removable by a string or wire when the container is at the proper depth in the tank. The sample is gently pulled out and transferred to a new container. Figure 3 shows a common type of Dip sampler.
-

- 4.3 When sampling liquid asphalts other than emulsions, fill the container to approximately 95% capacity; leaving a small amount of space for stirring the sample before the tests. When sampling emulsions, completely fill the container to avoid any air entrapment in the sample.
- 4.3.1 Use appropriate containers with a capacity corresponding to the required amount of material for sampling:
- liquid asphalt, other than emulsions and cutbacks: double-seal friction-top metal cans, clean and dust-free, dry, with a minimum capacity of 1 qt. (1 L);
 - emulsified asphalt: wide-mouth plastic jars, clean and dust-free, dry, with a minimum capacity of 1 qt. (1 L);
 - cutback asphalt: double-seal friction-top or screw-top metal cans, clean and dust-free, dry, with a minimum capacity of 1 qt. (1 L);
 - solid or semisolid bituminous materials from drums, packages, or cakes: friction-lid bucket or can, clean and dust-free, dry, with a minimum capacity of 1 gal. (4 L).
- 4.4 Seal the sample container. In the case of using friction-top metal cans, it is recommended to secure the lid using appropriate metal lid clips.
- 4.5 Proceed to Part IX—Recording, Labeling, Packaging, Storing, and Shipping of Samples within this test procedure.



Figure 1
Examples of Valves Commonly Used for Sampling Liquid Asphalt from Tanks

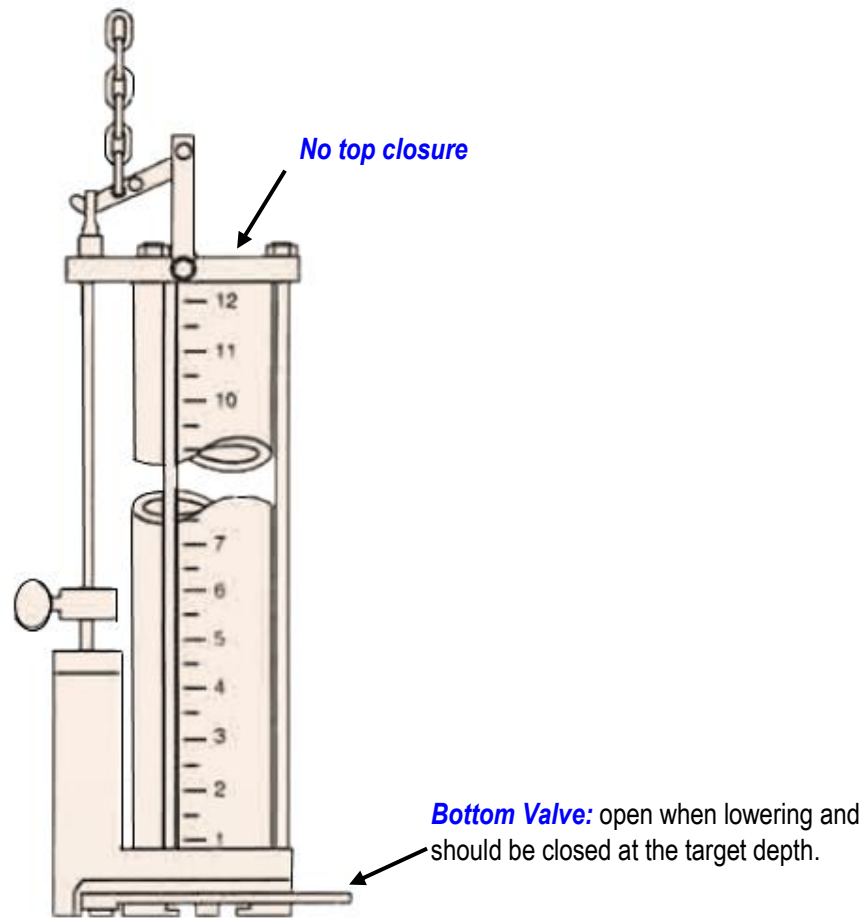

Figure 2

Schematics of an Acceptable Thief Sampler Device Used for Sampling Liquid Asphalt

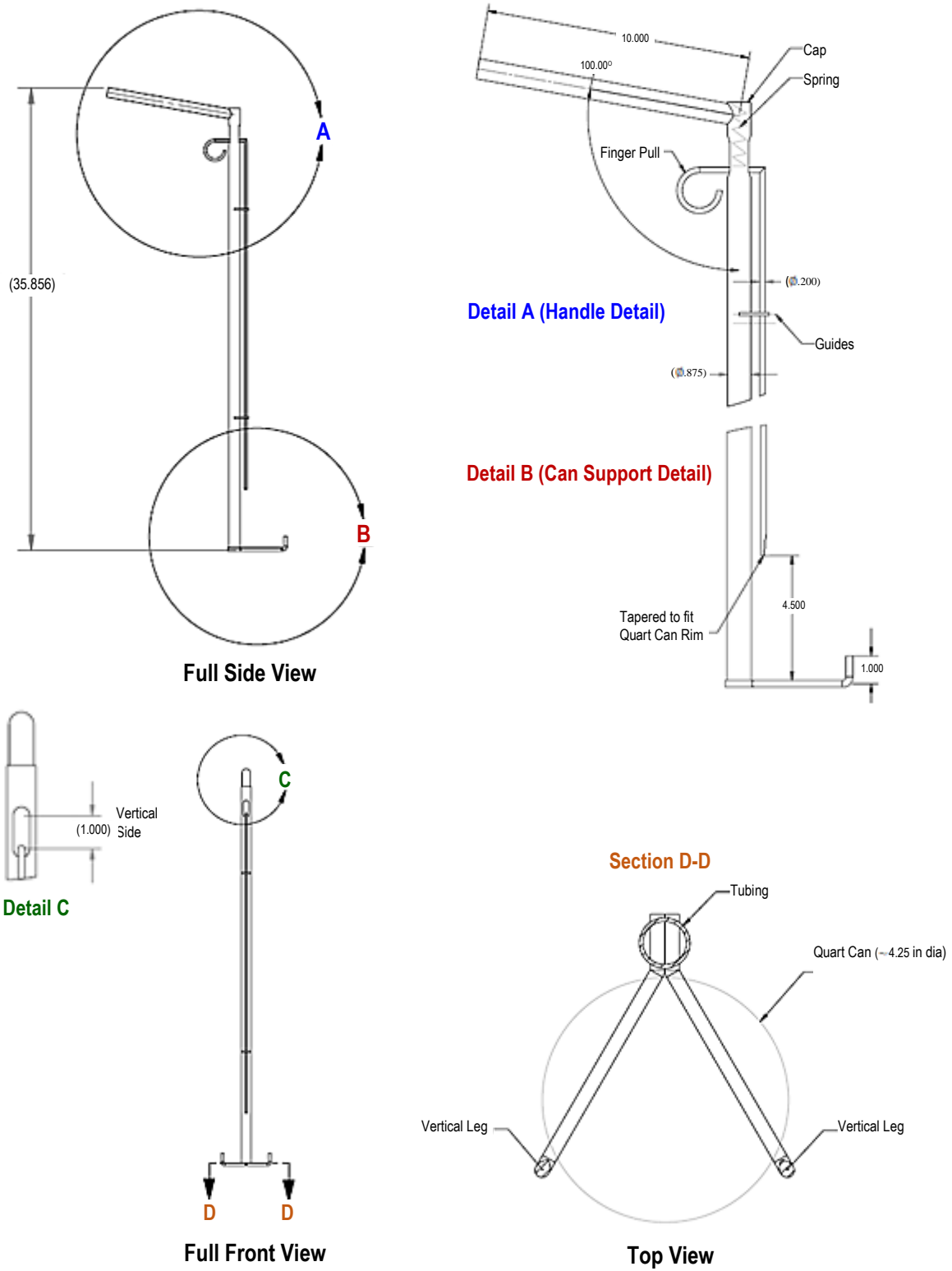

Figure 3
Schematics of a Common Dip Sampler Device Used for Sampling Liquid Asphalt

PART II—SAMPLING FROM PIPELINES

5. SCOPE

5.1 Samples can be taken from the pipeline when:

- loading or unloading tankers or barges;
- the pipeline is filling tank cars, distributors, or drums; or
- the asphalt line is feeding the mix plant.

5.2 Use the following procedure when sampling liquid bituminous materials from pipelines.

6. PROCEDURE

6.1 A sampling pipe of not more than 1/8 the diameter of the pipeline, with a drain cock used to regulate the flow through it, is required. Figure 4 shows common types of valves used for sampling liquid asphalt from pipelines. The sampling pipe should be inserted into the pipeline at a right location with its opening turned to face the flow of the liquid.

6.1.1 For a flow under pump pressure, the right location is the rising section of the line on the discharge side of the pump.

6.1.2 For a flow under gravity, the right locations are the parts of the pipeline which are completely full.

6.2 When sampling from a drain cock, open the drain cock and allow enough material (a minimum of 1 gal or 4 L) to flow into a waste container to clear the sample cock and sample line from old material.

6.2.1 Fill the sample container from the valve or drain cock.

6.2.1.1 When sampling liquid asphalts other than emulsions, fill the container to approximately 95% capacity; leaving a small amount of space for stirring the sample before the tests. When sampling emulsions, completely fill the container to avoid any air entrapment in the sample.

6.2.1.2 Use appropriate containers with a capacity corresponding to the required amount of material for sampling:

- liquid asphalt, other than emulsions and cutbacks: double-seal friction-top metal cans, clean and dust-free, dry, with a minimum capacity of 1 qt. (1 L);
- emulsified asphalt: wide-mouth plastic jars, clean and dust-free, dry, with a minimum capacity of 1 qt. (1 L);
- cutback asphalt: double-seal friction-top or screw-top metal cans, clean and dust-free, dry, with a minimum capacity of 1 qt. (1 L).

6.2.2 Tightly close and seal the sample container. In the case of using friction-top metal cans, it is recommended to secure the lid using appropriate metal lid clips.

6.2.3 Proceed to Part IX—Recording, Labeling, Packaging, Storing, and Shipping of Samples within this test procedure.

- 6.3 When a large quantity of liquid asphalt is being transferred through pipeline (e.g., loading or unloading tankers or barges), multiple number of 1-gal (4-L) samples should be taken to obtain an overall representative sample.
- 6.3.1 The minimum number of required samples depends upon the amount of the material being transferred. For instance, for loading or unloading of tankers or barges with a capacity of
- less than 25,000 barrels (4,000 m³), at least five 1-gal (4-L) samples is required, or
 - more than 25,000 barrels (4,000 m³), at least ten 1-gal (4-L) samples is required.
- 6.3.2 Sampling should be uniformly distributed during the loading or unloading process.
- 6.3.3 To obtain a representative sample, all the collected individual samples should be thoroughly mixed in a larger container (sample receiver) at the end of loading or unloading process. Then, a 1-gal (4-L) representative sample should be taken from the mixed material in the sample receiver.
- 6.3.4 Tightly close and seal the sample container. In the case of using friction-top metal cans, it is recommended to secure the lid using appropriate metal lid clips.
- 6.3.5 Proceed to Part IX—Recording, Labeling, Packaging, Storing, and Shipping of Samples within this test procedure.



Figure 4

Examples of Valves Commonly Used for Sampling Liquid Asphalt from Pipelines

PART III—SAMPLING FROM TANK CARS, TRUCKS, OR DISTRIBUTORS

7. SCOPE

- 7.1 Use this procedure when sampling liquid or semi-solid bituminous materials from tank cars, trucks, or distributors.
-

8. PROCEDURE

- 8.1 If possible or if there is a concern regarding the quality of the material delivered, carefully inspect the material for the presence of foam, sediment, or free water on top or bottom of the car or truck. Make notation of such observations.
- 8.2 When sampling semi-solid materials, heat the materials to fluidity. (Sample all liquid materials without heating, if possible.)
- 8.3 When sampling from distributors, circulate and mix the material thoroughly with the pump.
- 8.4 Wearing the required safety equipment, collect the sample using sampling port / valve designed on these delivery vehicles or distributor. Sampling valve should be installed at least 1 ft (305 mm) away from the shell of the tank and should be also labeled as "sampling valve." If only one sample is needed, it is recommended to obtain the sample halfway through the unloading process.
- 8.5 When sampling port or valve does not exist, a representative sample can be obtained by using Sampling Pipe Fitting or Thief or Dip Sampler method. In addition, samples from a distributor can also be obtained directly from the spray bar.
- 8.5.1 Sampling Pipe Fitting: sampling can also be done by mounting a detachable or permanent sampling pipe fitting in the discharge line, between the unloading pipe and hose, and close to the end. Figure 5 demonstrates schematics of a detachable sampling pipe fitting device. When unloading tanker trucks, using this device slowly, collect a sample from the middle third of the unloading process.
- 8.5.2 Thief or Dip Sampler Method: Obtain a sample from the top of the truck by lowering the sampling device through the top hatch, similar to what was described in Part I. Due to safety concerns, it is not recommended to take samples by Thief or Dip method from the top of the vehicle, unless no other method of sampling is available.
- 8.5.3 Sampling from the Spray Bar: when sampling from a distributor nozzle, allow at least one full shot after the start of the workday, or after cleaning the spray bar, to insure that any cleaning agent has been cleared from the spray bar.

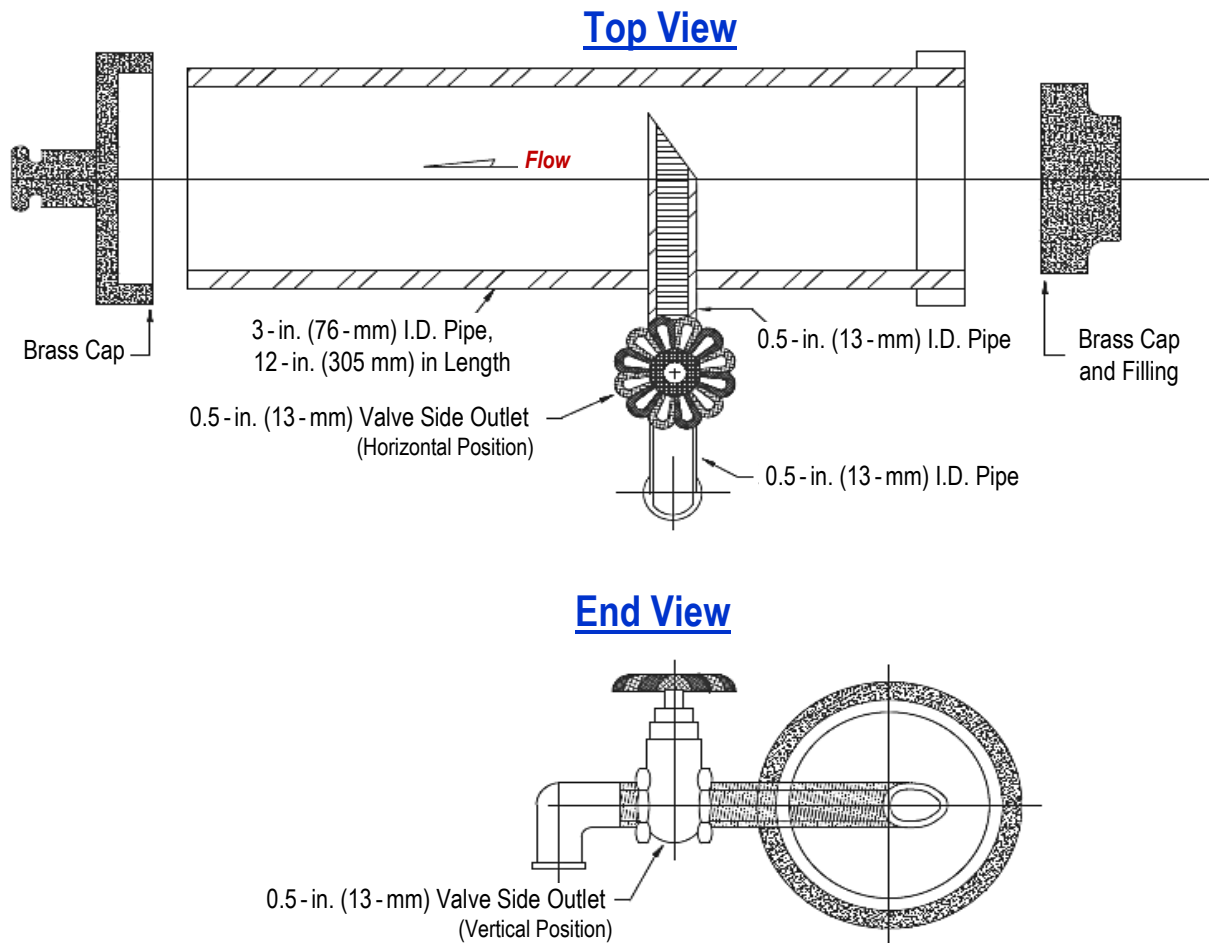

Figure 5

Schematics of a Typical Detachable Sampling Pipe Fitting Device

- 8.6 When obtaining a sample from the sampling port or Sampling Pipe Fitting (loading or unloading line), open the appropriate valve or drain cock and allow enough material (a minimum of 1 gal or 4 L) to flow into a waste container to ensure removal of old material and collection of a representative sample.
- 8.7 Pour the material into a clean container.
- 8.7.1 When sampling liquid asphalts other than emulsions, fill the container to approximately 95% capacity; leaving a small amount of space for stirring the sample before the tests. When sampling emulsions, completely fill the container to avoid any air entrapment in the sample.
- 8.7.2 Use appropriate containers with a capacity corresponding to the required amount of material for sampling:
- liquid asphalt, other than emulsions and cutbacks: double-seal friction-top metal cans, clean and dust-free, dry, with a minimum capacity of 1 qt. (1 L);
 - emulsified asphalt: wide-mouth plastic jars, clean and dust-free, dry, with a minimum capacity of 1 qt. (1 L);
 - cutback asphalt: double-seal friction-top or screw-top metal cans, clean and dust-free, dry, with a minimum capacity of 1 qt. (1 L).

- 8.8 Tightly close and seal the sample container. In the case of using friction-top metal cans, it is recommended to secure the lid using appropriate metal lid clips.
- 8.9 Proceed to Part IX—Recording, Labeling, Packaging, Storing, and Shipping of Samples within this test procedure.

PART IV—SAMPLING FROM IN-LINE BLENDED MATERIALS

9. SCOPE

- 9.1 Use this procedure when the material supplier is blending finished grades of asphalt material directly into trucks using an automatic blending system.
- 9.2 The producer should assign a batch number to each individual grade of asphalt produced through an automatic blender. The producer must change this number each time either of the blending stocks or formulation is changed.

10. PROCEDURE

- 10.1 Auto-sampling devices that collect samples, during or throughout the loading process, may be used as approved by the Engineer or as approved for use in the supplier's quality plan. Figure 6 shows an auto-sampler device installed towards the end of a loading pipeline. This type of auto-sampler collects a large number of small samples at constant intervals using compressed air force. Compressed air forces a plunger into the transfer line to capture a fixed volume of material and then the plunger will be pulled back to a position which allows the sample to drop by gravity into the sampling container.
- 10.2 If the auto-sampler device is not available, obtain the sample from a trial blend, the first truck of each batch using the procedure described in Part III, or from the loading pipeline using the procedure described in Part II.
- 10.3 When sampling liquid asphalts other than emulsions, fill the container to approximately 95% capacity; leaving a small amount of space for stirring the sample before the tests.
- 10.3.1 Use appropriate containers with a capacity corresponding to the required amount of material for sampling:
- liquid asphalt, other than emulsions and cutbacks: double-seal friction-top metal cans, clean and dust-free, dry, with a minimum capacity of 1 qt. (1 L).
- 10.4 Tightly close and seal the sample container. In the case of using friction-top metal cans, it is recommended to secure the lid using appropriate metal lid clips.
- 10.5 Proceed to Part IX—Recording, Labeling, Packaging, Storing, and Shipping of Samples within this test procedure.



Figure 6

An Autosampler Device Installed towards the End of a Loading Pipeline

PART V—SAMPLING FROM DRUMS, PACKAGES, OR CAKES

11. SCOPE

11.1 Use this procedure when sampling solid or semisolid bituminous materials from drums, packages, or cakes.

12. PROCEDURE

12.1 Collect the number of samples requested by the Engineer.

12.1.1 If sampling the lot of material from a single batch of the producer, select one unit at random for sampling.

12.1.2 If not sampling the lot of material from a single batch, or if a singular sample from the lot fails to meet specifications, select a number of units equal to the cube root of the total number of units in the lot, rounding up to the next whole number. For instance, take four samples for lots from 28 units up to 64 (4x4x4) units, and take five samples from lots of 65 and up to 125 (5x5x5) units. Table 1 summarizes the number of samples that need to be selected for different numbers of units.

Table 1
Recommended Number of Samples to be Selected

Total Number of Units	Number of Samples Need to be Selected
2 to 8	2
9 to 27	3
28 to 64	4
65 to 125	5
126 to 216	6
217 to 343	7
344 to 512	8

- 12.2 To collect a representative composite sample, obtain samples of material, each individually
- have a mass of at least 1/4 lb. (100 g), and
 - from locations at least 3 in. (76 mm) below the surface and 3 in. (76 mm) from the side of the container or from the middle of the cake.
- 12.2.1 Fill a 1 gal (4 L) friction-lid can or bucket to almost 95% of its capacity as the final sample.
- 12.2.2 Melt and thoroughly mix materials from the same batch to form one composite sample. Test materials not from the same batch separately. (Even when more than one batch is present in a particular lot, test the individual batches as composite samples if clearly identified.)
- 12.2.3 Tightly close and seal the sample container. In the case of using friction-top metal cans, it is recommended to secure the lid using appropriate metal lid clips.
- 12.3 If the containers of material are not unreasonably large for shipment, use an entire container as a sample.
- 12.4 Record sample details, label the sample, generate a [Form 202](#) (Identification of Material Samples), and ship the sample to MTD.

PART VI—SAMPLING PRE-MOLDED EXPANSION JOINT FILLER AND ASPHALT PLANK

13. SCOPE

- 13.1 Use this procedure when sampling pre-molded materials, such as joint filler and asphalt plank.

14. PROCEDURE

- 14.1 Take a sample at least 12 x 12 in. (30 x 30 cm) for each thickness of material, for each type, and for each producer.
- 14.2 When material is in irregular shapes or sizes, use a piece of at least 1 ft.² (900 cm²) of each thickness, type, and producer as the sample.
- Note 1**—Do not use pieces less than 4 in. (100 cm), in any dimension, as samples.
- 14.3 Enclose the sample in a box or tie it securely to a light piece of board or plywood and wrap it to avoid damage during shipment.

- 14.4 Record sample details, label the sample, generate a [Form 202](#) (Identification of Material Samples), and ship the sample to MTD.

PART VII—SAMPLING JOINT SEALERS

15. SCOPE

- 15.1 Use this procedure for all types of joint sealers, including hot-poured rubber, asphalt-rubber crack sealant, single component synthetic polymers, and two-component synthetic polymers. The manufacturer usually packages these materials in individual containers.

16. PROCEDURE

- 16.1 Collect the number of samples requested by the Engineer. It is recommended to submit one sample for each lot or batch number (numbered by manufacturer) of sealer in the shipment.
- 16.2 Avoid opening individual packages whenever possible. If the packages are not unreasonably large for shipment, use an entire package as the sample. For instance, when sampling two-component sealers, if the components are packaged together, as a can carrying a 'Piggyback' container inside, take one unit for the sample.
- 16.3 Sample large containers in accordance with Part V with the following considerations.
- 16.3.1 Hot Poured Rubber Asphalt Joint Sealer and Rubber Asphalt Crack Sealing Compound:
- Obtain one container from each batch or lot;
 - When several batches make up a shipment, combine them to make one lot; and
 - Take one sample to represent the shipment.
- 16.3.2 Single-Component, Ready Mixed, Cold-Applied Sealer:
- Stir thoroughly before sampling; and
 - Fill one bucket per sample.
- 16.3.3 Two-Component Sealers:
- Stir any liquid components thoroughly;
 - Pour from one can to a clean, empty container to check for settlement;
 - Take one full bucket sample for any liquid components; and
 - For solid or paste components, take a sample, of appropriate size, to mix with the bucket of liquid.
- 16.3.4 Seal new containers of any synthetic polymer materials immediately, to minimize exposure to air and to prevent premature curing.
- 16.4 Small samples of hot-applied material can be directly collected from the applicator, after dispensing enough material to ensure any leftover product in the hose or applicator has been purged.
- 16.5 For two-component materials, include specimens of each component, packaged together, of requisite sizes for the specified mix proportions.

- 16.6 Include specimens of primers with samples of sealants where primers are used.
- 16.7 Record sample details, label the sample, generate a [Form 202](#) (Identification of Material Samples), and ship the sample to MTD. Include the following information with the shipment:
- Consignment of Sample. (EXAMPLE: Requisition and Board Control Number, contractor, and project information, or warehouse name and location);
- Mixing proportions by weight or volume, as appropriate, for two-component materials; and
- The amount of material represented by the sample for single-component material, or of each component for two-component material.

PART VIII—SAMPLING BITUMINOUS MARKER ADHESIVE

17. SCOPE

- 17.1 Use this procedure for sampling bituminous marker adhesive.

18. PROCEDURE

- 18.1 Obtain a **12 to 15 lb. (5.5 to 7.0 kg)** segment in a box from each batch or lot. (The material, which is typically solid at room temperature, will have been hot-poured into the sample box by the manufacturer.)
- 18.2 When a shipment contains several batches, combine to make one lot **and take** one sample to represent the shipment
- 18.3 Record sample details, label the sample, generate a [Form 202](#) (Identification of Material Samples), and ship the sample to MTD. Include the following information with the shipment.

PART IX—RECORDING, LABELING, PACKAGING, STORING, AND SHIPPING OF SAMPLES

19. SCOPE

- 19.1 Use this procedure for recording, labeling, packaging, storing, and shipping of samples.

20. MATERIALS

- 20.1 Label maker, compatible with 24 mm (0.94 in.) TZe tapes and is able to connect to a PC and run P-touch Editor.
Note 2—Examples include Brother P-touch label maker models PT-D600 or PT-P700.
- 20.2 TZe-S251 Extra Strength Adhesive Tape, temperature resistant from **-112°F to 356°F (-80°C to 180°C)** and rated for rough, textured, and painted surfaces.
- 20.3 Shipping container **or box**, appropriate for shipping samples.

20.4 Labeling Marker, such as a Sharpie, magic marker, or felt tip pen.

21. PROCEDURE

- 21.1 After acquiring the sample in the appropriate sample container, attach the identifying tag or mark the sample container with the name of producer, producer facility location, type and grade of material, district, date sampled, and project information including highway and CSJ.
- 21.2 If the samples are shipped to Materials and Tests Division (MTD) for testing, proceed to Section 21.3. If the sample is being stored, proceed to Section 21.4.
Note 3— Collect split samples for all asphalt binder materials sent to MTD for testing.
Note 4— Refer to the [Asphalt Binder Inspection and Sampling Guidance](#) document for more information regarding asphalt binder samples.
- 21.3 Log sample into SiteManager and generate a SiteManager ID. Populate the fields in SiteManager that are needed to completely identify the sample.
- 21.3.1 Generate a Form 202 in SiteManager.
Note 5— Producers may manually fill the [Form 202](#) (Identification of Material Samples).
- 21.3.2 Copy and paste SiteManager ID into printer software and ensure bar code protocol “Code 128” is selected.
- 21.3.3 For asphalt samples, print three copies of the bar code and attach two bar codes to the sides of the sample container in the vertical direction.
Note 6—For samples composed of multiple samples, such as two part joint sealants, print and place as many bar codes as needed to attach two bar codes for each part of the products being tested, and print one additional bar code.
- 21.3.4 Print Form 202.
- 21.3.5 Place the samples in shipping container or box along with a copy of the Form 202 for each sample. Attach the additional bar code to the outside of the shipping box.
- 21.3.5.1 If multiple samples are shipped in the same shipping box, attach the corresponding bar code for each sample to the outside of the shipping box.
- 21.3.5.2 Do not include any other materials (e.g. aggregates, HMA, etc.) in the same shipping box used for shipping asphalt samples.
- 21.3.5.3 Use wadded paper (e.g., newspapers) as packing material. Avoid materials such as shredded paper, bubble wrap, and Styrofoam pellets.
- 21.3.6 Obtain the tracking number and add it to the sample in SiteManager.
- 21.3.7 Ship the samples to MTD.
- 21.4 For samples being stored, transport the samples to the designated storage area (e.g. district laboratory, area office, or other approved storage area.)
- 21.5 In SiteManager, associate the sample with the project information and document the number of transports received for each day.

21.6 Store the samples of hot-applied asphalt binders and cutback asphalts in the designated area for a minimum of one yr. The minimum storage time for emulsified asphalts is two mo. Organize the samples by sample type, date, and project.

Note 7—MTD may later request these samples for additional testing.

Special Specification 3077

Superpave Mixtures



1. DESCRIPTION

Construct a hot-mix asphalt (HMA) pavement layer composed of a compacted, Superpave (SP) mixture of aggregate and asphalt binder mixed hot in a mixing plant. Payment adjustments will apply to HMA placed under this specification unless the HMA is deemed exempt in accordance with Section 3077.4.9.4., "Exempt Production."

2. MATERIALS

Furnish uncontaminated materials of uniform quality that meet the requirements of the plans and specifications.

Notify the Engineer of all material sources and before changing any material source or formulation. The Engineer will verify that the specification requirements are met when the Contractor makes a source or formulation change and may require a new laboratory mixture design, trial batch, or both. The Engineer may sample and test project materials at any time during the project to verify specification compliance in accordance with Item 6, "Control of Materials."

- 2.1. **Aggregate.** Furnish aggregates from sources that conform to the requirements shown in Table 1 and as specified in this Section. Aggregate requirements in this Section, including those shown in Table 1, may be modified or eliminated when shown on the plans. Additional aggregate requirements may be specified when shown on the plans. Provide aggregate stockpiles that meet the definitions in this Section for coarse, intermediate, or fine aggregate. Aggregate from reclaimed asphalt pavement (RAP) is not required to meet Table 1 requirements unless otherwise shown on the plans. Supply aggregates that meet the definitions in [Tex-100-E](#) for crushed gravel or crushed stone. The Engineer will designate the plant or the quarry as the sampling location. Provide samples from materials produced for the project. The Engineer will establish the Surface Aggregate Classification (SAC) and perform Los Angeles abrasion, magnesium sulfate soundness, and Micro-Deval tests. Perform all other aggregate quality tests listed in Table 1. Document all test results on the mixture design report. The Engineer may perform tests on independent or split samples to verify Contractor test results. Stockpile aggregates for each source and type separately. Determine aggregate gradations for mixture design and production testing based on the washed sieve analysis given in [Tex-200-F](#), Part II.

- 2.1.1. **Coarse Aggregate.** Coarse aggregate stockpiles must have no more than 20% material passing the No. 8 sieve. Aggregates from sources listed in the Department's *Bituminous Rated Source Quality Catalog* (BRSQC) are preapproved for use. Use only the rated values for hot-mix listed in the BRSQC. Rated values for surface treatment (ST) do not apply to coarse aggregate sources used in hot-mix asphalt.

For sources not listed on the Department's BRSQC:

- build an individual stockpile for each material;
- request the Department test the stockpile for specification compliance; and
- once approved, do not add material to the stockpile unless otherwise approved.

Provide aggregate from non-listed sources only when tested by the Engineer and approved before use. Allow 30 calendar days for the Engineer to sample, test, and report results for non-listed sources.

Provide coarse aggregate with at least the minimum SAC shown on the plans. SAC requirements only apply to aggregates used on the surface of travel lanes. SAC requirements apply to aggregates used on surfaces other than travel lanes when shown on the plans. The SAC for sources on the Department's *Aggregate Quality Monitoring Program (AQMP)* ([Tex-499-A](#)) is listed in the BRSQC.

- 2.1.1.1. **Blending Class A and Class B Aggregates.** Class B aggregate meeting all other requirements in Table 1 may be blended with a Class A aggregate to meet requirements for Class A materials, unless otherwise shown on the plans. Ensure that at least 50% by weight, or volume if required, of the material retained on the No. 4 sieve comes from the Class A aggregate source when blending Class A and B aggregates to meet a Class A requirement unless otherwise shown on the plans. Blend by volume if the bulk specific gravities of the Class A and B aggregates differ by more than 0.300. Coarse aggregate from RAP and Recycled Asphalt Shingles (RAS) will be considered as Class B aggregate for blending purposes.

The Engineer may perform tests at any time during production, when the Contractor blends Class A and B aggregates to meet a Class A requirement, to ensure that at least 50% by weight, or volume if required, of the material retained on the No. 4 sieve comes from the Class A aggregate source. The Engineer will use the Department's mix design template, when electing to verify conformance, to calculate the percent of Class A aggregate retained on the No. 4 sieve by inputting the bin percentages shown from readouts in the control room at the time of production and stockpile gradations measured at the time of production. The Engineer may determine the gradations based on either washed or dry sieve analysis from samples obtained from individual aggregate cold feed bins or aggregate stockpiles. The Engineer may perform spot checks using the gradations supplied by the Contractor on the mixture design report as an input for the template; however, a failing spot check will require confirmation with a stockpile gradation determined by the Engineer.

- 2.1.1.2. **Micro-Deval Abrasion.** The Engineer will perform a minimum of one Micro-Deval abrasion test in accordance with [Tex-461-A](#) for each coarse aggregate source used in the mixture design that has a Rated Source Soundness Magnesium (RSSM) loss value greater than 15 as listed in the BRSQC. The Engineer will perform testing before the start of production and may perform additional testing at any time during production. The Engineer may obtain the coarse aggregate samples from each coarse aggregate source or may require the Contractor to obtain the samples. The Engineer may waive all Micro-Deval testing based on a satisfactory test history of the same aggregate source.

The Engineer will estimate the magnesium sulfate soundness loss for each coarse aggregate source, when tested, using the following formula:

$$Mg_{est.} = (RSSM)(MD_{act.}/RSMD)$$

where:

$Mg_{est.}$ = magnesium sulfate soundness loss

$MD_{act.}$ = actual Micro-Deval percent loss

$RSMD$ = Rated Source Micro-Deval

When the estimated magnesium sulfate soundness loss is greater than the maximum magnesium sulfate soundness loss specified, the coarse aggregate source will not be allowed for use unless otherwise approved. The Engineer will consult the Soils and Aggregates Section of the Materials and Tests Division, and additional testing may be required before granting approval.

- 2.1.2. **Intermediate Aggregate.** Aggregates not meeting the definition of coarse or fine aggregate will be defined as intermediate aggregate. Supply intermediate aggregates, when used that are free from organic impurities. The Engineer may test the intermediate aggregate in accordance with [Tex-408-A](#) to verify the material is free from organic impurities. Supply intermediate aggregate from coarse aggregate sources, when used that meet the requirements shown in Table 1 unless otherwise approved.

Test the stockpile if 10% or more of the stockpile is retained on the No. 4 sieve, and verify that it meets the requirements in Table 1 for crushed face count ([Tex-460-A](#)) and flat and elongated particles ([Tex-280-F](#)).

2.1.3.

Fine Aggregate. Fine aggregates consist of manufactured sands, screenings, and field sands. Fine aggregate stockpiles must meet the gradation requirements in Table 2. Supply fine aggregates that are free from organic impurities. The Engineer may test the fine aggregate in accordance with [Tex-408-A](#) to verify the material is free from organic impurities. Unless otherwise shown on the plans, up to 10% of the total aggregate may be field sand or other uncrushed fine aggregate. Use fine aggregate, with the exception of field sand, from coarse aggregate sources that meet the requirements shown in Table 1 unless otherwise approved.

Test the stockpile if 10% or more of the stockpile is retained on the No. 4 sieve and verify that it meets the requirements in Table 1 for crushed face count ([Tex-460-A](#)) and flat and elongated particles ([Tex-280-F](#)).

Table 1
Aggregate Quality Requirements

Property	Test Method	Requirement
Coarse Aggregate		
SAC	Tex-499-A (AQMP)	As shown on the plans
Deleterious material, %, Max	Tex-217-F , Part I	1.0
Decantation, %, Max	Tex-217-F , Part II	1.5
Micro-Deval abrasion, %	Tex-461-A	Note 1
Los Angeles abrasion, %, Max	Tex-410-A	35 ²
Magnesium sulfate soundness, 5 cycles, %, Max	Tex-411-A	25 ³
Crushed face count, ⁴ %, Min	Tex-460-A , Part I	85
Flat and elongated particles @ 5:1, %, Max	Tex-280-F	10
Fine Aggregate		
Linear shrinkage, %, Max	Tex-107-E	3
Sand equivalent, %, Min	Tex-203-F	45

- Used to estimate the magnesium sulfate soundness loss in accordance with Section 3077.2.1.1.2., "Micro-Deval Abrasion."
- For base mixtures defined in Section 3077.2.7., "Recycled Materials," the Los Angeles abrasion may be increased to a maximum of 40%.
- For base mixtures defined in Section 3077.2.7., "Recycled Materials," the magnesium sulfate soundness, five cycles, may be increased to a maximum of 30%.
- Only applies to crushed gravel.

Table 2
Gradation Requirements for Fine Aggregate

Sieve Size	% Passing by Weight or Volume
3/8"	100
#8	70–100
#200	0–30

2.2.

Mineral Filler. Mineral filler consists of finely divided mineral matter such as agricultural lime, crusher fines, hydrated lime, or fly ash. Mineral filler is allowed unless otherwise shown on the plans. Use no more than 2% hydrated lime or fly ash unless otherwise shown on the plans. Use no more than 1% hydrated lime if a substitute binder is used unless otherwise shown on the plans or allowed. Test all mineral fillers except hydrated lime and fly ash in accordance with [Tex-107-E](#) to ensure specification compliance. The plans may require or disallow specific mineral fillers. Provide mineral filler, when used, that:

- is sufficiently dry, free-flowing, and free from clumps and foreign matter as determined by the Engineer;
- does not exceed 3% linear shrinkage when tested in accordance with [Tex-107-E](#); and
- meets the gradation requirements in Table 3, unless otherwise shown on the plans.

Table 3
Gradation Requirements for Mineral Filler

Sieve Size	% Passing by Weight or Volume
#8	100
#200	55–100

2.3.

Baghouse Fines. Fines collected by the baghouse or other dust-collecting equipment may be reintroduced into the mixing drum.

- 2.4. **Asphalt Binder.** Furnish the type and grade of performance-graded (PG) asphalt specified on the plans.
- 2.5. **Tack Coat.** Furnish CSS-1H, SS-1H, or a PG binder with a minimum high-temperature grade of PG 58 for tack coat binder in accordance with Item 300, "Asphalts, Oils, and Emulsions." Specialized tack coat materials listed on the Department's MPL are allowed or required when shown on the plans. Do not dilute emulsified asphalts at the terminal, in the field, or at any other location before use.
- 2.6. **Additives.** Use the type and rate of additive specified when shown on the plans. Additives that facilitate mixing, compaction, or improve the quality of the mixture are allowed when approved. Provide the Engineer with documentation such as the bill of lading showing the quantity of additives used in the project unless otherwise directed.
- 2.6.1. **Lime and Liquid Antistripping Agent.** When lime or a liquid antistripping agent is used, add in accordance with Item 301, "Asphalt Antistripping Agents." Do not add lime directly into the mixing drum of any plant where lime is removed through the exhaust stream unless the plant has a baghouse or dust collection system that reintroduces the lime into the drum.
- 2.6.2. **Warm Mix Asphalt (WMA).** Warm Mix Asphalt (WMA) is defined as HMA that is produced within a target temperature discharge range of 215°F and 275°F using approved WMA additives or processes from the Department's MPL.
- WMA is allowed for use on all projects and is required when shown on the plans. When WMA is required, the maximum placement or target discharge temperature for WMA will be set at a value below 275°F.
- Department-approved WMA additives or processes may be used to facilitate mixing and compaction of HMA produced at target discharge temperatures above 275°F; however, such mixtures will not be defined as WMA.
- 2.6.3. **Compaction Aid.** Compaction Aid is defined as a chemical warm mix additive that is used to produce an asphalt mixture at a discharge temperature greater than 275°F.
- Compaction Aid is allowed for use on all projects and is required when shown on the plans.
- 2.7. **Recycled Materials.** Use of RAP and RAS is permitted unless otherwise shown on the plans. Use of RAS is restricted to only intermediate and base mixes unless otherwise shown on the plans. Do not exceed the maximum allowable percentages of RAP and RAS shown in Table 4. The allowable percentages shown in Table 4 may be decreased or increased when shown on the plans. Determine the asphalt binder content and gradation of the RAP and RAS stockpiles for mixture design purposes in accordance with [Tex-236-F](#), Part I. The Engineer may verify the asphalt binder content of the stockpiles at any time during production. Perform other tests on RAP and RAS when shown on the plans. Asphalt binder from RAP and RAS is designated as recycled asphalt binder. Calculate and ensure that the ratio of the recycled asphalt binder to total binder does not exceed the percentages shown in Table 5 during mixture design and HMA production when RAP or RAS is used. Use a separate cold feed bin for each stockpile of RAP and RAS during HMA production.
- Surface, intermediate, and base mixes referenced in Tables 4 and 5 are defined as follows:
- **Surface.** The final HMA lift placed at the top of the pavement structure or placed directly below mixtures produced in accordance with Items 316, 342, 347, or 348;
 - **Intermediate.** Mixtures placed below an HMA surface mix and less than or equal to 8.0 in. from the riding surface; and
 - **Base.** Mixtures placed greater than 8.0 in. from the riding surface. Unless otherwise shown on the plans, mixtures used for bond breaker are defined as base mixtures.
- 2.7.1. **RAP.** RAP is salvaged, milled, pulverized, broken, or crushed asphalt pavement. Fractionated RAP is defined as a stockpile that contains RAP material with a minimum of 95.0% passing the 3/8-in. or 1/2-in.

sieve, before burning in the ignition oven, unless otherwise approved. The Engineer may allow the Contractor to use an alternate to the 3/8-in. or 1/2-in. screen to fractionate the RAP.

Use of Contractor-owned RAP including HMA plant waste is permitted unless otherwise shown on the plans. Department-owned RAP stockpiles are available for the Contractor's use when the stockpile locations are shown on the plans. If Department-owned RAP is available for the Contractor's use, the Contractor may use Contractor-owned fractionated RAP and replace it with an equal quantity of Department-owned RAP. Department-owned RAP generated through required work on the Contract is available for the Contractor's use when shown on the plans. Perform any necessary tests to ensure Contractor- or Department-owned RAP is appropriate for use. The Department will not perform any tests or assume any liability for the quality of the Department-owned RAP unless otherwise shown on the plans. The Contractor will retain ownership of RAP generated on the project when shown on the plans.

Do not use Department- or Contractor-owned RAP contaminated with dirt or other objectionable materials. Do not use Department- or Contractor-owned RAP if the decantation value exceeds 5% and the plasticity index is greater than eight. Test the stockpiled RAP for decantation in accordance with [Tex-406-A](#), Part I. Determine the plasticity index in accordance with [Tex-106-E](#) if the decantation value exceeds 5%. The decantation and plasticity index requirements do not apply to RAP samples with asphalt removed by extraction or ignition.

Do not intermingle Contractor-owned RAP stockpiles with Department-owned RAP stockpiles. Remove unused Contractor-owned RAP material from the project site upon completion of the project. Return unused Department-owned RAP to the designated stockpile location.

Table 4
Maximum Allowable Amounts of RAP¹

Maximum Allowable Fractionated RAP (%)		
Surface	Intermediate	Base
20.0	30.0	35.0

1. Must also meet the recycled binder to total binder ratio shown in Table 5.

2.7.2.

RAS. Use of post-manufactured RAS or post-consumer RAS (tear-offs) is not permitted in surface mixtures unless otherwise shown on the plans. RAS may be used in intermediate and base mixtures unless otherwise shown on the plans. Up to 3% RAS may be used separately or as a replacement for fractionated RAP in accordance with Table 4 and Table 5. RAS is defined as processed asphalt shingle material from manufacturing of asphalt roofing shingles or from re-roofing residential structures. Post-manufactured RAS is processed manufacturer's shingle scrap by-product. Post-consumer RAS is processed shingle scrap removed from residential structures. Comply with all regulatory requirements stipulated for RAS by the TCEQ. RAS may be used separately or in conjunction with RAP.

Process the RAS by ambient grinding or granulating such that 100% of the particles pass the 3/8 in. sieve when tested in accordance with [Tex-200-F](#), Part I. Perform a sieve analysis on processed RAS material before extraction (or ignition) of the asphalt binder.

Add sand meeting the requirements of Table 1 and Table 2 or fine RAP to RAS stockpiles if needed to keep the processed material workable. Any stockpile that contains RAS will be considered a RAS stockpile and be limited to no more than 3.0% of the HMA mixture in accordance with Table 4.

Certify compliance of the RAS with [DMS-11000](#), "Evaluating and Using Nonhazardous Recyclable Materials Guidelines." Treat RAS as an established nonhazardous recyclable material if it has not come into contact with any hazardous materials. Use RAS from shingle sources on the Department's MPL. Remove substantially all materials before use that are not part of the shingle, such as wood, paper, metal, plastic, and felt paper. Determine the deleterious content of RAS material for mixture design purposes in accordance with [Tex-217-F](#), Part III. Do not use RAS if deleterious materials are more than 0.5% of the stockpiled RAS unless

otherwise approved. Submit a sample for approval before submitting the mixture design. The Department will perform the testing for deleterious material of RAS to determine specification compliance.

2.8.

Substitute Binders. Unless otherwise shown on the plans, the Contractor may use a substitute PG binder listed in Table 5 instead of the PG binder originally specified if using recycled materials, and if the substitute PG binder and mixture made with the substitute PG binder meet the following:

- the substitute binder meets the specification requirements for the substitute binder grade in accordance with Section 300.2.10., "Performance-Graded Binders;" and
- the mixture has less than 10.0 mm of rutting on the Hamburg Wheel test ([Tex-242-F](#)) after the number of passes required for the originally specified binder. Use of substitute PG binders may only be allowed at the discretion of the Engineer if the Hamburg Wheel test results are between 10.0 mm and 12.5 mm.

Table 5
Allowable Substitute PG Binders and Maximum Recycled Binder Ratios

Originally Specified PG Binder	Allowable Substitute PG Binder for Surface Mixes	Allowable Substitute PG Binder for Intermediate and Base Mixes	Maximum Ratio of Recycled Binder ¹ to Total Binder (%)		
			Surface	Intermediate	Base
76-22 ^{4,5}	70-22	70-22	15.0	25.0	30.0
70-22 ^{2,5}	N/A	64-22	15.0	25.0	30.0
64-22 ^{2,3}	N/A	N/A	15.0	25.0	30.0
76-28 ^{4,5}	70-28	70-28	15.0	25.0	30.0
70-28 ^{2,5}	N/A	64-28	15.0	25.0	30.0
64-28 ^{2,3}	N/A	N/A	15.0	25.0	30.0

1. Combined recycled binder from RAP and RAS. RAS is not permitted in surface mixtures unless otherwise shown on the plans.
2. Binder substitution is not allowed for surface mixtures.
3. Binder substitution is not allowed for intermediate and base mixtures.
4. Use no more than 15.0% recycled binder in surface mixtures when using this originally specified PG binder.
5. Use no more than 25.0% recycled binder when using this originally specified PG binder for intermediate mixtures. Use no more than 30.0% recycled binder when using this originally specified PG binder for base mixtures.

3. EQUIPMENT

Provide required or necessary equipment in accordance with Item 320, "Equipment for Asphalt Concrete Pavement."

4. CONSTRUCTION

Produce, haul, place, and compact the specified paving mixture. In addition to tests required by the specification, Contractors may perform other QC tests as deemed necessary. At any time during the project, the Engineer may perform production and placement tests as deemed necessary in accordance with Item 5, "Control of the Work." Schedule and participate in a mandatory pre-paving meeting with the Engineer on or before the first day of paving unless otherwise shown on the plans.

4.1.

Certification. Personnel certified by the Department-approved hot-mix asphalt certification program must conduct all mixture designs, sampling, and testing in accordance with Table 6. Supply the Engineer with a list of certified personnel and copies of their current certificates before beginning production and when personnel

changes are made. Provide a mixture design developed and signed by a Level 2 certified specialist. Provide Level 1A certified specialists at the plant during production operations. Provide Level 1B certified specialists to conduct placement tests. Provide AGG101 certified specialists for aggregate testing.

Table 6
Test Methods, Test Responsibility, and Minimum Certification Levels

Test Description	Test Method	Contractor	Engineer	Level ¹
1. Aggregate and Recycled Material Testing				
Sampling	Tex-221-F	✓	✓	1A/AGG101
Dry sieve	Tex-200-F, Part I	✓	✓	1A/AGG101
Washed sieve	Tex-200-F, Part II	✓	✓	1A/AGG101
Deleterious material	Tex-217-F, Parts I & III	✓	✓	AGG101
Decantation	Tex-217-F, Part II	✓	✓	AGG101
Los Angeles abrasion	Tex-410-A		✓	TxDOT
Magnesium sulfate soundness	Tex-411-A		✓	TxDOT
Micro-Deval abrasion	Tex-461-A		✓	AGG101
Crushed face count	Tex-460-A	✓	✓	AGG101
Flat and elongated particles	Tex-280-F	✓	✓	AGG101
Linear shrinkage	Tex-107-E	✓	✓	AGG101
Sand equivalent	Tex-203-F	✓	✓	AGG101
Bulk specific gravity	Tex-201-F	✓	✓	AGG101
Unit weight	Tex-404-A	✓	✓	AGG101
Organic impurities	Tex-408-A	✓	✓	AGG101
2. Asphalt Binder & Tack Coat Sampling				
Asphalt binder sampling	Tex-500-C, Part II	✓	✓	1A/1B
Tack coat sampling	Tex-500-C, Part III	✓	✓	1A/1B
3. Mix Design & Verification				
Design and JMF changes	Tex-204-F	✓	✓	2
Mixing	Tex-205-F	✓	✓	2
Molding (SGC)	Tex-241-F	✓	✓	1A
Laboratory-molded density	Tex-207-F, Parts I & VI	✓	✓	1A
Rice gravity	Tex-227-F, Part II	✓	✓	1A
Ignition oven correction factors ²	Tex-236-F, Part II	✓	✓	2
Indirect tensile strength	Tex-226-F	✓	✓	1A
Hamburg Wheel test	Tex-242-F	✓	✓	1A
Boil test	Tex-530-C	✓	✓	1A
4. Production Testing				
Selecting production random numbers	Tex-225-F, Part I		✓	1A
Mixture sampling	Tex-222-F	✓	✓	1A/1B
Molding (SGC)	Tex-241-F	✓	✓	1A
Laboratory-molded density	Tex-207-F, Parts I & VI	✓	✓	1A
Rice gravity	Tex-227-F, Part II	✓	✓	1A
Gradation & asphalt binder content ²	Tex-236-F, Part I	✓	✓	1A
Control charts	Tex-233-F	✓	✓	1A
Moisture content	Tex-212-F, Part II	✓	✓	1A/AGG101
Hamburg Wheel test	Tex-242-F	✓	✓	1A
Micro-Deval abrasion	Tex-461-A		✓	AGG101
Boil test	Tex-530-C	✓	✓	1A
Abson recovery	Tex-211-F		✓	TxDOT
5. Placement Testing				
Selecting placement random numbers	Tex-225-F, Part II		✓	1B
Trimming roadway cores	Tex-251-F, Parts I & II	✓	✓	1A/1B
In-place air voids	Tex-207-F, Parts I & VI	✓	✓	1A
In-place density (nuclear method)	Tex-207-F, Part III	✓		1B
Establish rolling pattern	Tex-207-F, Part IV	✓		1B
Control charts	Tex-233-F	✓	✓	1A
Ride quality measurement	Tex-1001-S	✓	✓	Note 3
Segregation (density profile)	Tex-207-F, Part V	✓	✓	1B
Longitudinal joint density	Tex-207-F, Part VII	✓	✓	1B
Thermal profile	Tex-244-F	✓	✓	1B
Shear Bond Strength Test	Tex-249-F		✓	TxDOT

- Level 1A, 1B, AGG101, and 2 are certification levels provided by the Hot Mix Asphalt Center certification program.
- Refer to Section 3077.4.9.2.3., "Production Testing," for exceptions to using an ignition oven.
- Profiler and operator are required to be certified at the Texas A&M Transportation Institute facility when Surface Test Type B is specified.

4.2.

Reporting and Responsibilities. Use Department-provided templates to record and calculate all test data, including mixture design, production and placement QC/QA, control charts, thermal profiles, segregation density profiles, and longitudinal joint density. Obtain the current version of the templates at <http://www.txdot.gov/inside-txdot/forms-publications/consultants-contractors/forms/site-manager.html> or from the Engineer. The Engineer and the Contractor will provide any available test results to the other party when requested. The maximum allowable time for the Contractor and Engineer to exchange test data is as given in Table 7 unless otherwise approved. The Engineer and the Contractor will immediately report to the other party any test result that requires suspension of production or placement, a payment adjustment less than 1.000, or that fails to meet the specification requirements. Record and electronically submit all test results and pertinent information on Department-provided templates.

Subsequent sublots placed after test results are available to the Contractor, which require suspension of operations, may be considered unauthorized work. Unauthorized work will be accepted or rejected at the discretion of the Engineer in accordance with Article 5.3., "Conformity with Plans, Specifications, and Special Provisions."

**Table 7
Reporting Schedule**

Description	Reported By	Reported To	To Be Reported Within
Production Quality Control			
Gradation ¹	Contractor	Engineer	1 working day of completion of the subplot
Asphalt binder content ¹			
Laboratory-molded density ²			
Moisture content ³			
Boil test ³			
Production Quality Assurance			
Gradation ³	Engineer	Contractor	1 working day of completion of the subplot
Asphalt binder content ³			
Laboratory-molded density ¹			
Hamburg Wheel test ⁴			
Boil test ³			
Binder tests ⁴			
Placement Quality Control			
In-place air voids ²	Contractor	Engineer	1 working day of completion of the lot
Segregation ¹			
Longitudinal joint density ¹			
Thermal profile ¹			
Placement Quality Assurance			
In-place air voids ¹	Engineer	Contractor	1 working day after receiving the trimmed cores ⁵
Segregation ³			1 working day of completion of the lot
Longitudinal joint density ³			
Thermal profile ³			
Aging ratio ⁴			
Payment adjustment summary	Engineer	Contractor	2 working days of performing all required tests and receiving Contractor test data

1. These tests are required on every subplot.
2. Optional test. When performed on split samples, report the results as soon as they become available.
3. To be performed at the frequency specified in Table 17 or as shown on the plans.
4. To be reported as soon as the results become available.
5. Two days are allowed if cores cannot be dried to constant weight within 1 day.

The Engineer will use the Department-provided template to calculate all payment adjustment factors for the lot. Sublot samples may be discarded after the Engineer and Contractor sign off on the payment adjustment summary documentation for the lot.

Use the procedures described in [Tex-233-F](#) to plot the results of all quality control (QC) and quality assurance (QA) testing. Update the control charts as soon as test results for each subplot become available.

Make the control charts readily accessible at the field laboratory. The Engineer may suspend production for failure to update control charts.

- 4.3. **Quality Control Plan (QCP).** Develop and follow the QCP in detail. Obtain approval for changes to the QCP made during the project. The Engineer may suspend operations if the Contractor fails to comply with the QCP.

Submit a written QCP before the mandatory pre-paving meeting. Receive approval of the QCP before beginning production. Include the following items in the QCP:

- 4.3.1. **Project Personnel.** For project personnel, include:
- a list of individuals responsible for QC with authority to take corrective action;
 - current contact information for each individual listed; and
 - current copies of certification documents for individuals performing specified QC functions.
- 4.3.2. **Material Delivery and Storage.** For material delivery and storage, include:
- the sequence of material processing, delivery, and minimum quantities to assure continuous plant operations;
 - aggregate stockpiling procedures to avoid contamination and segregation;
 - frequency, type, and timing of aggregate stockpile testing to assure conformance of material requirements before mixture production; and
 - procedure for monitoring the quality and variability of asphalt binder.
- 4.3.3. **Production.** For production, include:
- loader operation procedures to avoid contamination in cold bins;
 - procedures for calibrating and controlling cold feeds;
 - procedures to eliminate debris or oversized material;
 - procedures for adding and verifying rates of each applicable mixture component (e.g., aggregate, asphalt binder, RAP, RAS, lime, liquid antistriper, WMA);
 - procedures for reporting job control test results; and
 - procedures to avoid segregation and drain-down in the silo.
- 4.3.4. **Loading and Transporting.** For loading and transporting, include:
- type and application method for release agents; and
 - truck loading procedures to avoid segregation.
- 4.3.5. **Placement and Compaction.** For placement and compaction, include:
- proposed agenda for mandatory pre-paving meeting, including date and location;
 - proposed paving plan (e.g., paving widths, joint offsets, and lift thicknesses);
 - type and application method for release agents in the paver and on rollers, shovels, lutes, and other utensils;
 - procedures for the transfer of mixture into the paver, while avoiding segregation and preventing material spillage;
 - process to balance production, delivery, paving, and compaction to achieve continuous placement operations and good ride quality;
 - paver operations (e.g., operation of wings, height of mixture in auger chamber) to avoid physical and thermal segregation and other surface irregularities; and
 - procedures to construct quality longitudinal and transverse joints.

4.4. Mixture Design.

4.4.1. **Design Requirements.** Use the SP design procedure provided in [Tex-204-F](#), unless otherwise shown on the plans. Design the mixture to meet the requirements listed in Tables 1, 2, 3, 4, 5, 8, 9, 10, and 11.

Design the mixture at 50 gyrations (Ndesign). Use a target laboratory-molded density of 96.0% to design the mixture; however, adjustments can be made to the Ndesign value as noted in Table 10. The Ndesign level may be reduced to at least 35 gyrations at the Contractor's discretion.

Use an approved laboratory from the Department's MPL to perform the Hamburg Wheel test and provide results with the mixture design, or provide the laboratory mixture and request that the Department perform the Hamburg Wheel test. The Engineer will be allowed 10 working days to provide the Contractor with Hamburg Wheel test results on the laboratory mixture design.

The Engineer will provide the mixture design when shown on the plans. The Contractor may submit a new mixture design at any time during the project. The Engineer will verify and approve all mixture designs (JMF1) before the Contractor can begin production.

The aggregate gradation may pass below or through the reference zone shown in Table 9 unless otherwise shown on the plans. Design a mixture with a gradation that has stone-on-stone contact and passes below the reference zone shown in Table 9 when shown on the plans. Verify stone-on-stone contact using the method given in the SP design procedure in [Tex-204-F](#), Part IV.

Provide the Engineer with a mixture design report using the Department-provided template. Include the following items in the report:

- the combined aggregate gradation, source, specific gravity, and percent of each material used;
- asphalt binder content and aggregate gradation of RAP and RAS stockpiles;
- the Ndesign level used;
- results of all applicable tests;
- the mixing and molding temperatures;
- the signature of the Level 2 person or persons that performed the design;
- the date the mixture design was performed; and
- a unique identification number for the mixture design.

Table 8
Master Gradation Limits (% Passing by Weight or Volume) and VMA Requirements

Sieve Size	SP-B Intermediate	SP-C Surface	SP-D Fine Mixture
2"	–	–	–
1-1/2"	100.0 ¹	–	–
1"	98.0–100.0	100.0 ¹	–
3/4"	90.0–100.0	98.0–100.0	100.0 ¹
1/2"	Note ²	90.0–100.0	98.0–100.0
3/8"	–	Note ²	90.0–100.0
#4	23.0–90.0	28.0–90.0	32.0–90.0
#8	23.0–34.6	28.0–37.0	32.0–40.0
#16	2.0–28.3	2.0–31.6	2.0–37.6
#30	2.0–20.7	2.0–23.1	2.0–27.5
#50	2.0–13.7	2.0–15.5	2.0–18.7
#200	2.0–8.0	2.0–10.0	2.0–10.0
Design VMA, % Minimum			
–	14.0	15.0	16.0
Production (Plant-Produced) VMA, % Minimum			
–	13.5	14.5	15.5

1. Defined as maximum sieve size. No tolerance allowed.
2. Must retain at least 10% cumulative.

Table 9
Reference Zones (% Passing by Weight or Volume)

Sieve Size	SP-B Intermediate	SP-C Surface	SP-D Fine Mixture
2"	–	–	–
1-1/2"	–	–	–
1"	–	–	–
3/4"	–	–	–
1/2"	–	–	–
3/8"	–	–	–
#4	–	–	–
#8	34.6–34.6	39.1–39.1	47.2–47.2
#16	22.3–28.3	25.6–31.6	31.6–37.6
#30	16.7–20.7	19.1–23.1	23.5–27.5
#50	13.7–13.7	15.5–15.5	18.7–18.7
#200	–	–	–

Table 10
Laboratory Mixture Design Properties

Mixture Property	Test Method	Requirement
Target laboratory-molded density, %	Tex-207-F	96.0
Design gyrations (Ndesign)	Tex-241-F	50 ¹
Indirect tensile strength (dry), psi	Tex-226-F	85–200 ²
Dust/asphalt binder ratio ³	–	0.6–1.4
Boil test ⁴	Tex-530-C	–

- Adjust within a range of 35–100 gyrations when shown on the plans or specification or mutually agreed between the Engineer and Contractor.
- The Engineer may allow the IDT strength to exceed 200 psi if the corresponding Hamburg Wheel rut depth is greater than 3.0 mm and less than 12.5 mm.
- Defined as % passing #200 sieve divided by asphalt binder content.
- Used to establish baseline for comparison to production results. May be waived when approved.

Table 11
Hamburg Wheel Test Requirements

High-Temperature Binder Grade	Test Method	Minimum # of Passes @ 12.5 mm ¹ Rut Depth, Tested @ 50°C
PG 64 or lower	Tex-242-F	10,000 ²
PG 70		15,000 ³
PG 76 or higher		20,000

- When the rut depth at the required minimum number of passes is less than 3 mm, the Engineer may require the Contractor to lower the Ndesign level to at least 35 gyrations.
- May be decreased to at least 5,000 passes when shown on the plans.
- May be decreased to at least 10,000 passes when shown on the plans.

4.4.2. **Job-Mix Formula Approval.** The job-mix formula (JMF) is the combined aggregate gradation, Ndesign level, and target asphalt percentage used to establish target values for hot-mix production. JMF1 is the original laboratory mixture design used to produce the trial batch. When WMA is used, JMF1 may be designed and submitted to the Engineer without including the WMA additive. When WMA is used, document the additive or process used and recommended rate on the JMF1 submittal. The Engineer and the Contractor will verify JMF1 based on plant-produced mixture from the trial batch unless otherwise approved. The Engineer may accept an existing mixture design previously used on a Department project and may waive the trial batch to verify JMF1. The Department may require the Contractor to reimburse the Department for verification tests if more than two trial batches per design are required.

4.4.2.1. **Contractor's Responsibilities.**

4.4.2.1.1. **Providing Superpave Gyrotory Compactor (SGC).** Furnish an SGC calibrated in accordance with [Tex-241-F](#) for molding production samples. Locate the SGC at the Engineer's field laboratory and make the SGC available to the Engineer for use in molding production samples.

- 4.4.2.1.2. **Gyratory Compactor Correlation Factors.** Use [Tex-206-F](#), Part II, to perform a gyratory compactor correlation when the Engineer uses a different SGC. Apply the correlation factor to all subsequent production test results.
- 4.4.2.1.3. **Submitting JMF1.** Furnish a mix design report (JMF1) with representative samples of all component materials and request approval to produce the trial batch. Provide approximately 10,000 g of the design mixture if opting to have the Department perform the Hamburg Wheel test on the laboratory mixture, and request that the Department perform the test.
- 4.4.2.1.4. **Supplying Aggregates.** Provide approximately 40 lb. of each aggregate stockpile unless otherwise directed.
- 4.4.2.1.5. **Supplying Asphalt.** Provide at least 1 gal. of the asphalt material and enough quantities of any additives proposed for use.
- 4.4.2.1.6. **Ignition Oven Correction Factors.** Determine the aggregate and asphalt correction factors from the ignition oven in accordance with [Tex-236-F](#), Part II. Provide correction factors that are not more than 12 months old. Provide the Engineer with split samples of the mixtures before the trial batch production, including all additives (except water), and blank samples used to determine the correction factors for the ignition oven used for QA testing during production. Correction factors established from a previously approved mixture design may be used for the current mixture design if the mixture design and ignition oven are the same as previously used, unless otherwise directed.
- 4.4.2.1.7. **Boil Test.** Perform the test and retain the tested sample from [Tex-530-C](#) until completion of the project or as directed. Use this sample for comparison purposes during production. The Engineer may waive the requirement for the boil test.
- 4.4.2.1.8. **Trial Batch Production.** Provide a plant-produced trial batch upon receiving conditional approval of JMF1 and authorization to produce a trial batch, including the WMA additive or process if applicable, for verification testing of JMF1 and development of JMF2. Produce a trial batch mixture that meets the requirements in Table 4, Table 5, and Table 12. The Engineer may accept test results from recent production of the same mixture instead of a new trial batch.
- 4.4.2.1.9. **Trial Batch Production Equipment.** Use only equipment and materials proposed for use on the project to produce the trial batch.
- 4.4.2.1.10. **Trial Batch Quantity.** Produce enough quantity of the trial batch to ensure that the mixture meets the specification requirements.
- 4.4.2.1.11. **Number of Trial Batches.** Produce trial batches as necessary to obtain a mixture that meets the specification requirements.
- 4.4.2.1.12. **Trial Batch Sampling.** Obtain a representative sample of the trial batch and split it into 3 equal portions in accordance with [Tex-222-F](#). Label these portions as "Contractor," "Engineer," and "Referee." Deliver samples to the appropriate laboratory as directed.
- 4.4.2.1.13. **Trial Batch Testing.** Test the trial batch to ensure the mixture produced using the proposed JMF1 meets the mixture requirements in Table 12. Ensure the trial batch mixture is also in compliance with the Hamburg Wheel-requirement in Table 11. Use a Department-approved laboratory to perform the Hamburg Wheel test on the trial batch mixture or request that the Department perform the Hamburg Wheel test.
- The Engineer will be allowed 10 working days to provide the Contractor with Hamburg Wheel test results on the trial batch. Provide the Engineer with a copy of the trial batch test results.
- 4.4.2.1.14. **Development of JMF2.** Evaluate the trial batch test results after the Engineer grants full approval of JMF1 based on results from the trial batch, determine the optimum mixture proportions, and submit as JMF2.

Adjust the asphalt binder content or gradation to achieve the specified target laboratory-molded density. The asphalt binder content established for JMF2 is not required to be within any tolerance of the optimum asphalt binder content established for JMF1; however, mixture produced using JMF2 must meet the voids in mineral aggregates (VMA) requirements for production shown in Table 8. If the optimum asphalt binder content for JMF2 is more than 0.5% lower than the optimum asphalt binder content for JMF1, the Engineer may perform or require the Contractor to perform [Tex-226-F](#) on Lot 1 production to confirm the indirect tensile strength does not exceed 200 psi. Verify that JMF2 meets the mixture requirements in Table 4 and Table 5.

- 4.4.2.1.15. **Mixture Production.** Use JMF2 to produce Lot 1 as described in Section 3077.4.9.3.1.1., “Lot 1 Placement,” after receiving approval for JMF2 and a passing result from the Department’s or a Department-approved laboratory’s Hamburg Wheel test on the trial batch. If desired, proceed to Lot 1 production, once JMF2 is approved, at the Contractor’s risk without receiving the results from the Department’s Hamburg Wheel test on the trial batch.

Notify the Engineer if electing to proceed without Hamburg Wheel test results from the trial batch. Note that the Engineer may require up to the entire subplot of any mixture failing the Hamburg Wheel test to be removed and replaced at the Contractor’s expense.

- 4.4.2.1.16. **Development of JMF3.** Evaluate the test results from Lot 1, determine the optimum mixture proportions, and submit as JMF3 for use in Lot 2.

- 4.4.2.1.17. **JMF Adjustments.** If JMF adjustments are necessary to achieve the specified requirements, make the adjustment before beginning a new lot. The adjusted JMF must:

- be provided to the Engineer in writing before the start of a new lot;
- be numbered in sequence to the previous JMF;
- meet the mixture requirements in Table 4 and Table 5;
- meet the master gradation limits shown in Table 8; and
- be within the operational tolerances of JMF2 listed in Table 12.

- 4.4.2.1.18. **Requesting Referee Testing.** Use referee testing, if needed, in accordance with Section 3077.4.9.1., “Referee Testing,” to resolve testing differences with the Engineer.

Table 12
Operational Tolerances

Description	Test Method	Allowable Difference Between Trial Batch and JMF1 Target	Allowable Difference from Current JMF Target	Allowable Difference between Contractor and Engineer ¹
Individual % retained for #8 sieve and larger	Tex-200-F or Tex-236-F	Must be Within Master Grading Limits in Table 8	±5.0 ^{2,3}	±5.0
Individual % retained for sieves smaller than #8 and larger than #200			±3.0 ^{2,3}	±3.0
% passing the #200 sieve			±2.0 ^{2,3}	±1.6
Asphalt binder content, %	Tex-236-F	±0.5	±0.3 ³	±0.3
Dust/asphalt binder ratio ⁴	–	Note 5	Note 5	N/A
Laboratory-molded density, %	Tex-207-F	±1.0	±1.0	±0.5
In-place air voids, %		N/A	N/A	±1.0
Laboratory-molded bulk specific gravity		N/A	N/A	±0.020
VMA, % min	Tex-204-F	Note 6	Note 6	N/A
Theoretical maximum specific (Rice) gravity	Tex-227-F	N/A	N/A	±0.020

- Contractor may request referee testing only when values exceed these tolerances.
- When within these tolerances, mixture production gradations may fall outside the master grading limits; however, the % passing the #200 will be considered out of tolerance when outside the master grading limits.
- Only applies to mixture produced for Lot 1 and higher.
- Defined as % passing #200 sieve divided by asphalt binder content.
- Verify that Table 10 requirement is met.
- Verify that Table 8 requirements are met.

4.4.2.2. **Engineer's Responsibilities.**

4.4.2.2.1. **Gyratory Compactor.** The Engineer will use a Department SGC, calibrated in accordance with [Tex-241-F](#), to mold samples for laboratory mixture design verification. For molding trial batch and production specimens, the Engineer will use the Contractor-provided SGC at the field laboratory or provide and use a Department SGC at an alternate location. The Engineer will make the Contractor-provided SGC in the Department field laboratory available to the Contractor for molding verification samples.

4.4.2.2.2. **Conditional Approval of JMF1 and Authorizing Trial Batch.** The Engineer will review and verify conformance of the following information within two working days of receipt:

- the Contractor's mix design report (JMF1);
- the Contractor-provided Hamburg Wheel test results;
- all required materials including aggregates, asphalt, additives, and recycled materials; and
- the mixture specifications.

The Engineer will grant the Contractor conditional approval of JMF1 if the information provided on the paper copy of JMF1 indicates that the Contractor's mixture design meets the specifications. When the Contractor does not provide Hamburg Wheel test results with laboratory mixture design, 10 working days are allowed for conditional approval of JMF1. The Engineer will base full approval of JMF1 on the test results on mixture from the trial batch.

Unless waived, the Engineer will determine the Micro-Deval abrasion loss in accordance with Section 3077.2.1.1.2., "Micro-Deval Abrasion." If the Engineer's test results are pending after two working days, conditional approval of JMF1 will still be granted within 2 working days of receiving JMF1. When the Engineer's test results become available, they will be used for specification compliance.

After conditionally approving JMF1, including either Contractor- or Department-supplied Hamburg Wheel test results, the Contractor is authorized to produce a trial batch.

- 4.4.2.2.3. **Hamburg Wheel Testing of JMF1.** If the Contractor requests the option to have the Department perform the Hamburg Wheel test on the laboratory mixture, the Engineer will mold samples in accordance with [Tex-242-F](#) to verify compliance with the Hamburg Wheel test requirement in Table 11.
- 4.4.2.2.4. **Ignition Oven Correction Factors.** The Engineer will use the split samples provided by the Contractor to determine the aggregate and asphalt correction factors for the ignition oven used for QA testing during production in accordance with [Tex-236-F](#), Part II. Provide correction factors that are not more than 12 months old.
- 4.4.2.2.5. **Testing the Trial Batch.** Within 1 full working day, the Engineer will sample and test the trial batch to ensure that the mixture meets the requirements in Table 12. If the Contractor requests the option to have the Department perform the Hamburg Wheel test on the trial batch mixture, the Engineer will mold samples in accordance with [Tex-242-F](#) to verify compliance with the Hamburg Wheel test requirement in Table 11.
- The Engineer will have the option to perform the following tests on the trial batch:
- [Tex-226-F](#), to verify that the indirect tensile strength meets the requirement shown in Table 10; and
 - [Tex-530-C](#), to retain and use for comparison purposes during production.
- 4.4.2.2.6. **Full Approval of JMF1.** The Engineer will grant full approval of JMF1 and authorize the Contractor to proceed with developing JMF2 if the Engineer's results for the trial batch meet the requirements in Table 12. The Engineer will notify the Contractor that an additional trial batch is required if the trial batch does not meet these requirements.
- 4.4.2.2.7. **Approval of JMF2.** The Engineer will approve JMF2 within one working day if the mixture meets the requirements in Table 5 and the gradation meets the master grading limits shown in Table 8. The asphalt binder content established for JMF2 is not required to be within any tolerance of the optimum asphalt binder content established for JMF1; however, mixture produced using JMF2 must meet the VMA requirements shown in Table 8. If the optimum asphalt binder content for JMF2 is more than 0.5% lower than the optimum asphalt binder content for JMF1, the Engineer may perform or require the Contractor to perform [Tex-226-F](#) on Lot 1 production to confirm the indirect tensile strength does not exceed 200 psi.
- 4.4.2.2.8. **Approval of Lot 1 Production.** The Engineer will authorize the Contractor to proceed with Lot 1 production (using JMF2) as soon as a passing result is achieved from the Department's or a Department-approved laboratory's Hamburg Wheel test on the trial batch. The Contractor may proceed at its own risk with Lot 1 production without the results from the Hamburg Wheel test on the trial batch.
- If the Department's or Department-approved laboratory's sample from the trial batch fails the Hamburg Wheel test, the Engineer will suspend production until further Hamburg Wheel tests meet the specified values. The Engineer may require up to the entire subplot of any mixture failing the Hamburg Wheel test be removed and replaced at the Contractor's expense.
- 4.4.2.2.9. **Approval of JMF3 and Subsequent JMF Changes.** JMF3 and subsequent JMF changes are approved if they meet the mixture requirements shown in Table 4, Table 5, and the master grading limits shown in Table 8, and are within the operational tolerances of JMF2 shown in Table 12.
- 4.5. **Production Operations.** Perform a new trial batch when the plant or plant location is changed. Take corrective action and receive approval to proceed after any production suspension for noncompliance to the specification. Submit a new mix design and perform a new trial batch when the asphalt binder content of:
- any RAP stockpile used in the mix is more than 0.5% higher than the value shown on the mixture design report; or
 - RAS stockpile used in the mix is more than 2.0% higher than the value shown on the mixture design report.

4.5.1. **Storage and Heating of Materials.** Do not heat the asphalt binder above the temperatures specified in Item 300, "Asphalts, Oils, and Emulsions," or outside the manufacturer's recommended values. Provide the Engineer with daily records of asphalt binder and hot-mix asphalt discharge temperatures (in legible and discernible increments) in accordance with Item 320, "Equipment for Asphalt Concrete Pavement," unless otherwise directed. Do not store mixture for a period long enough to affect the quality of the mixture, nor in any case longer than 12 hr. unless otherwise approved.

4.5.2. **Mixing and Discharge of Materials.** Notify the Engineer of the target discharge temperature and produce the mixture within 25°F of the target. Monitor the temperature of the material in the truck before shipping to ensure that it does not exceed the maximum production temperatures listed in Table 13 (or 275°F for WMA). The Department will not pay for or allow placement of any mixture produced above the maximum production temperatures listed in Table 13.

Table 13
Maximum Production Temperature

High-Temperature Binder Grade ¹	Maximum Production Temperature
PG 64	325°F
PG 70	335°F
PG 76	345°F

1. The high-temperature binder grade refers to the high-temperature grade of the virgin asphalt binder used to produce the mixture.

Produce WMA within the target discharge temperature range of 215°F and 275°F when WMA is required. Take corrective action any time the discharge temperature of the WMA exceeds the target discharge range. The Engineer may suspend production operations if the Contractor's corrective action is not successful at controlling the production temperature within the target discharge range. Note that when WMA is produced, it may be necessary to adjust burners to ensure complete combustion such that no burner fuel residue remains in the mixture.

Control the mixing time and temperature so that substantially all moisture is removed from the mixture before discharging from the plant. Determine the moisture content, if requested, by oven-drying in accordance with [Tex-212-F](#), Part II, and verify that the mixture contains no more than 0.2% of moisture by weight. Obtain the sample immediately after discharging the mixture into the truck, and perform the test promptly.

4.6. **Hauling Operations.** Clean all truck beds before use to ensure that mixture is not contaminated. Use a release agent shown on the Department's MPL to coat the inside bed of the truck when necessary.

Use equipment for hauling as defined in Section 3077.4.7.3.3., "Hauling Equipment." Use other hauling equipment only when allowed.

4.7. **Placement Operations.** Collect haul tickets from each load of mixture delivered to the project and provide the Department's copy to the Engineer approximately every hour or as directed. Use a hand-held thermal camera or infrared thermometer, when a thermal imaging system is not used, to measure and record the internal temperature of the mixture as discharged from the truck or Material Transfer Device (MTD) before or as the mix enters the paver and an approximate station number or GPS coordinates on each ticket. Calculate the daily yield and cumulative yield for the specified lift and provide to the Engineer at the end of paving operations for each day unless otherwise directed. The Engineer may suspend production if the Contractor fails to produce and provide haul tickets and yield calculations by the end of paving operations for each day.

Prepare the surface by removing raised pavement markers and objectionable material such as moisture, dirt, sand, leaves, and other loose impediments from the surface before placing mixture. Remove vegetation from pavement edges. Place the mixture to meet the typical section requirements and produce a smooth, finished surface with a uniform appearance and texture. Offset longitudinal joints of successive courses of hot-mix by at least 6 in. Place mixture so that longitudinal joints on the surface course coincide with lane lines and are not placed in the wheel path, or as directed. Ensure that all finished surfaces will drain properly. Place the

mixture at the rate or thickness shown on the plans. The Engineer will use the guidelines in Table 14 to determine the compacted lift thickness of each layer when multiple lifts are required. The thickness determined is based on the rate of 110 lb./sq. yd. for each inch of pavement unless otherwise shown on the plans.

Table 14
Compacted Lift Thickness and Required Core Height

Mixture Type	Compacted Lift Thickness Guidelines		Minimum Untrimmed Core Height (in.) Eligible for Testing
	Minimum (in.)	Maximum (in.)	
SP-B	2.50	4.0	2.00
SP-C	2.00	3.0	1.25
SP-D	1.25	2.0	1.25

4.7.1. **Weather Conditions.**

4.7.1.1. **When Using a Thermal Imaging System.** Place mixture when the roadway is dry and the roadway surface temperature is at or above the temperatures listed in Table 15A. The Engineer may restrict the Contractor from paving surface mixtures if the ambient temperature is likely to drop below 32°F within 12 hr. of paving. Place mixtures only when weather conditions and moisture conditions of the roadway surface are suitable as determined by the Engineer. Provide output data from the thermal imaging system to demonstrate to the Engineer that no recurring severe thermal segregation exists in accordance with Section 3077.4.7.3.1.2., "Thermal Imaging System."

Table 15A
Minimum Pavement Surface Temperatures

High-Temperature Binder Grade ¹	Minimum Pavement Surface Temperatures (°F)	
	Subsurface Layers or Night Paving Operations	Surface Layers Placed in Daylight Operations
PG 64	35	40
PG 70	45 ²	50 ²
PG 76	45 ²	50 ²

1. The high-temperature binder grade refers to the high-temperature grade of the virgin asphalt binder used to produce the mixture.
2. Contractors may pave at temperatures 10°F lower than these values when a chemical WMA additive is used as a compaction aid in the mixture or when using WMA.

4.7.1.2. **When Not Using a Thermal Imaging System.** When using a thermal camera instead of the thermal imaging system, place mixture when the roadway surface temperature is at or above the temperatures listed in Table 15B unless otherwise approved or as shown on the plans. Measure the roadway surface temperature with a hand-held thermal camera or infrared thermometer. The Engineer may allow mixture placement to begin before the roadway surface reaches the required temperature if conditions are such that the roadway surface will reach the required temperature within 2 hr. of beginning placement operations. Place mixtures only when weather conditions and moisture conditions of the roadway surface are suitable as determined by the Engineer. The Engineer may restrict the Contractor from paving if the ambient temperature is likely to drop below 32°F within 12 hr. of paving.

Table 15B
Minimum Pavement Surface Temperatures

High-Temperature Binder Grade ¹	Minimum Pavement Surface Temperatures (°F)	
	Subsurface Layers or Night Paving Operations	Surface Layers Placed in Daylight Operations
PG 64	45	50
PG 70	55 ²	60 ²
PG 76	60 ²	60 ²

1. The high-temperature binder grade refers to the high-temperature grade of the virgin asphalt binder used to produce the mixture.
2. Contractors may pave at temperatures 10°F lower than these values when a chemical WMA additive is used as a compaction aid in the mixture, when using WMA, or utilizing a paving process with equipment that eliminates thermal segregation. In such cases, for each subplot and in the presence of the Engineer, use a hand-held thermal camera operated in accordance with [Tex-244-F](#) to demonstrate to the satisfaction of the Engineer that the uncompacted mat has no more than 10°F of thermal segregation.

4.7.2. Tack Coat.

4.7.2.1. **Application.** Clean the surface before placing the tack coat. The Engineer will set the rate between 0.04 and 0.10 gal. of residual asphalt per square yard of surface area. Apply a uniform tack coat at the specified rate unless otherwise directed. Apply the tack coat in a uniform manner to avoid streaks and other irregular patterns. Apply the tack coat to all surfaces that will come in contact with the subsequent HMA placement, unless otherwise directed. Allow adequate time for emulsion to break completely before placing any material. Prevent splattering of tack coat when placed adjacent to curb, gutter, and structures. Do not dilute emulsified asphalts at the terminal, in the field, or at any other location before use.

4.7.2.2. **Sampling.** The Engineer will obtain at least one sample of the tack coat binder per project in accordance with [Tex-500-C](#), Part III, and test it to verify compliance with Item 300, "Asphalts, Oils, and Emulsions." The Engineer will notify the Contractor when the sampling will occur and will witness the collection of the sample from the asphalt distributor immediately before use.

For emulsions, the Engineer may test as often as necessary to ensure the residual of the emulsion is greater than or equal to the specification requirement in Item 300, "Asphalts, Oils, and Emulsions."

4.7.3. **Lay-Down Operations.** Use the placement temperatures in Table 16 to establish the minimum placement temperature of mixture delivered to the paver.

Table 16
Minimum Mixture Placement Temperature

High-Temperature Binder Grade ¹	Minimum Placement Temperature (Before Entering Paver) ^{2,3}
PG 64	260°F
PG 70	270°F
PG 76	280°F

1. The high-temperature binder grade refers to the high-temperature grade of the virgin asphalt binder used to produce the mixture.
2. Minimum placement temperatures may be reduced 10°F if using a chemical WMA additive as a compaction aid.
3. When using WMA, the minimum placement temperature is 215°F.

4.7.3.1. **Thermal Profile.** Use a hand-held thermal camera or a thermal imaging system to obtain a continuous thermal profile in accordance with [Tex-244-F](#). Thermal profiles are not applicable in areas described in Section 3077.4.9.3.1.4., "Miscellaneous Areas."

4.7.3.1.1. **Thermal Segregation.**

- 4.7.3.1.1.1. **Moderate.** Any areas that have a temperature differential greater than 25°F, but not exceeding 50°F, are deemed as moderate thermal segregation.
- 4.7.3.1.1.2. **Severe.** Any areas that have a temperature differential greater than 50°F are deemed as severe thermal segregation.
- 4.7.3.1.2. **Thermal Imaging System.** Review the output results when a thermal imaging system is used, and provide the automated report described in [Tex-244-F](#) to the Engineer daily unless otherwise directed. Modify the paving process as necessary to eliminate any recurring (moderate or severe) thermal segregation identified by the thermal imaging system. The Engineer may suspend paving operations if the Contractor cannot successfully modify the paving process to eliminate recurring severe thermal segregation. Density profiles are not required and not applicable when using a thermal imaging system. Provide the Engineer with electronic copies of all daily data files that can be used with the thermal imaging system software to generate temperature profile plots daily or upon completion of the project or as requested by the Engineer.
- 4.7.3.1.3. **Thermal Camera.** When using a thermal camera instead of the thermal imaging system, take immediate corrective action to eliminate recurring moderate thermal segregation when a hand-held thermal camera is used. Evaluate areas with moderate thermal segregation by performing density profiles in accordance with Section 3077.4.9.3.3.2., "Segregation (Density Profile)." Provide the Engineer with the thermal profile of every subplot within one working day of the completion of each lot. When requested by the Engineer, provide the thermal images generated using the thermal camera. Report the results of each thermal profile in accordance with Section 3077.4.2., "Reporting and Responsibilities." The Engineer will use a hand-held thermal camera to obtain a thermal profile at least once per project. No production or placement payment adjustments greater than 1.000 will be paid for any subplot that contains severe thermal segregation. Suspend operations and take immediate corrective action to eliminate severe thermal segregation unless otherwise directed. Resume operations when the Engineer determines that subsequent production will meet the requirements of this Section. Evaluate areas with severe thermal segregation by performing density profiles in accordance with Section 3077.4.9.3.3.2., "Segregation (Density Profile)." Remove and replace the material in any areas that have both severe thermal segregation and a failing result for Segregation (Density Profile) unless otherwise directed. The subplot in question may receive a production and placement payment adjustment greater than 1.000, if applicable, when the defective material is successfully removed and replaced.
- 4.7.3.2. **Windrow Operations.** Operate windrow pickup equipment so that when hot-mix is placed in windrows, substantially all the mixture deposited on the roadbed is picked up and loaded into the paver.
- 4.7.3.3. **Hauling Equipment.** Use belly dumps, live bottom, or end dump trucks to haul and transfer mixture; however, with exception of paving miscellaneous areas, end dump trucks are only allowed when used in conjunction with an MTD with remixing capability or when a thermal imaging system is used unless otherwise allowed.
- 4.7.3.4. **Screed Heaters.** Turn off screed heaters to prevent overheating of the mat if the paver stops for more than 5 min. The Engineer may evaluate the suspect area in accordance with Section 3077.4.9.3.3.4., "Recovered Asphalt Dynamic Shear Rheometer (DSR)," if the screed heater remains on for more than 5 min. while the paver is stopped.
- 4.8. **Compaction.** Compact the pavement uniformly to contain between 3.7% and 7.5% in-place air voids. Take immediate corrective action to bring the operation within 3.7% and 7.5% when the in-place air voids exceed the range of these tolerances. The Engineer will allow paving to resume when the proposed corrective action is likely to yield between 3.7% and 7.5% in-place air voids.
- Obtain cores in areas placed under Exempt Production, as directed, at locations determined by the Engineer. The Engineer may test these cores and suspend operations or require removal and replacement if the in-place air voids are less than 2.7% or more than 9.0%. Areas defined in Section 3077.4.9.3.1.4., "Miscellaneous Areas," are not subject to in-place air void determination.

Furnish the type, size, and number of rollers required for compaction as approved. Use additional rollers as required to remove any roller marks. Use only water or an approved release agent on rollers, tamps, and other compaction equipment unless otherwise directed.

Use the control strip method shown in [Tex-207-F](#), Part IV, on the first day of production to establish the rolling pattern that will produce the desired in-place air voids unless otherwise directed.

Use tamps to thoroughly compact the edges of the pavement along curbs, headers, and similar structures and in locations that will not allow thorough compaction with rollers. The Engineer may require rolling with a trench roller on widened areas, in trenches, and in other limited areas.

Complete all compaction operations before the pavement temperature drops below 160°F unless otherwise allowed. The Engineer may allow compaction with a light finish roller operated in static mode for pavement temperatures below 160°F.

Allow the compacted pavement to cool to 160°F or lower before opening to traffic unless otherwise directed. Sprinkle the finished mat with water or limewater, when directed, to expedite opening the roadway to traffic.

- 4.9. **Acceptance Plan.** Payment adjustments for the material will be in accordance with Article 3077.6., "Payment."

Sample and test the hot-mix on a lot and subplot basis. Suspend production until test results or other information indicates to the satisfaction of the Engineer that the next material produced or placed will result in pay factors of at least 1.000 if the production pay factor given in Section 3077.6.1., "Production Payment Adjustment Factors," for two consecutive lots or the placement pay factor given in Section 3077.6.2., "Placement Payment Adjustment Factors," for two consecutive lots is below 1.000.

- 4.9.1. **Referee Testing.** The Materials and Tests Division is the referee laboratory. The Contractor may request referee testing if a "remove and replace" condition is determined based on the Engineer's test results, or if the differences between Contractor and Engineer test results exceed the maximum allowable difference shown in Table 12 and the differences cannot be resolved. The Contractor may also request referee testing if the Engineer's test results require suspension of production and the Contractor's test results are within specification limits. Make the request within 5 working days after receiving test results and cores from the Engineer. Referee tests will be performed only on the subplot in question and only for the particular tests in question. Allow 10 working days from the time the referee laboratory receives the samples for test results to be reported. The Department may require the Contractor to reimburse the Department for referee tests if more than three referee tests per project are required and the Engineer's test results are closer to the referee test results than the Contractor's test results.

The Materials and Tests Division will determine the laboratory-molded density based on the molded specific gravity and the maximum theoretical specific gravity of the referee sample. The in-place air voids will be determined based on the bulk specific gravity of the cores, as determined by the referee laboratory and the Engineer's average maximum theoretical specific gravity for the lot. With the exception of "remove and replace" conditions, referee test results are final and will establish payment adjustment factors for the subplot in question. The Contractor may decline referee testing and accept the Engineer's test results when the placement payment adjustment factor for any subplot results in a "remove and replace" condition. Placement sublots subject to be removed and replaced will be further evaluated in accordance with Section 3077.6.2.2., "Placement Sublots Subject to Removal and Replacement."

- 4.9.2. **Production Acceptance.**

- 4.9.2.1. **Production Lot.** A production lot consists of four equal sublots. The default quantity for Lot 1 is 1,000 tons; however, when requested by the Contractor, the Engineer may increase the quantity for Lot 1 to no more than 4,000 tons. The Engineer will select subsequent lot sizes based on the anticipated daily production such

that approximately three to four sublots are produced each day. The lot size will be between 1,000 tons and 4,000 tons. The Engineer may change the lot size before the Contractor begins any lot.

If the optimum asphalt binder content for JMF2 is more than 0.5% lower than the optimum asphalt binder content for JMF1, the Engineer may perform or require the Contractor to perform [Tex-226-F](#) on Lot 1 to confirm the indirect tensile strength does not exceed 200 psi. Take corrective action to bring the mixture within specification compliance if the indirect tensile strength exceeds 200 psi unless otherwise directed.

- 4.9.2.1.1. **Incomplete Production Lots.** If a lot is begun but cannot be completed, such as on the last day of production or in other circumstances deemed appropriate, the Engineer may close the lot. Adjust the payment for the incomplete lot in accordance with Section 3077.6.1., "Production Payment Adjustment Factors." Close all lots within five working days unless otherwise allowed.
- 4.9.2.2. **Production Sampling.**
- 4.9.2.2.1. **Mixture Sampling.** Obtain hot-mix samples from trucks at the plant in accordance with [Tex-222-F](#). The sampler will split each sample into three equal portions in accordance with [Tex-200-F](#) and label these portions as "Contractor," "Engineer," and "Referee." The Engineer will perform or witness the sample splitting and take immediate possession of the samples labeled "Engineer" and "Referee." The Engineer will maintain the custody of the samples labeled "Engineer" and "Referee" until the Department's testing is completed.
- 4.9.2.2.1.1. **Random Sample.** At the beginning of the project, the Engineer will select random numbers for all production sublots. Determine sample locations in accordance with [Tex-225-F](#). Take one sample for each subplot at the randomly selected location. The Engineer will perform or witness the sampling of production sublots.
- 4.9.2.2.1.2. **Blind Sample.** For one subplot per lot, the Engineer will obtain and test a "blind" sample instead of the random sample collected by the Contractor. Test either the "blind" or the random sample; however, referee testing (if applicable) will be based on a comparison of results from the "blind" sample. The location of the Engineer's "blind" sample will not be disclosed to the Contractor. The Engineer's "blind" sample may be randomly selected in accordance with [Tex-225-F](#) for any subplot or selected at the discretion of the Engineer. The Engineer will use the Contractor's split sample for sublots not sampled by the Engineer.
- 4.9.2.2.2. **Informational Shear Bond Strength Testing.** Select one random subplot from Lot 2 or higher for shear bond strength testing. Obtain full depth cores in accordance with [Tex-249-F](#). Label the cores with the Control Section Job (CSJ), producer of the tack coat, mix type, shot rate, lot, and subplot number and provide to the Engineer. The Engineer will ship the cores to the Materials and Tests Division or district laboratory for shear bond strength testing. Results from these tests will not be used for specification compliance.
- 4.9.2.2.3. **Asphalt Binder Sampling.** Obtain a 1-qt. sample of the asphalt binder witnessed by the Engineer for each lot of mixture produced. The Contractor will notify the Engineer when the sampling will occur. Obtain the sample at approximately the same time the mixture random sample is obtained. Sample from a port located immediately upstream from the mixing drum or pug mill and upstream from the introduction of any additives in accordance with [Tex-500-C](#), Part II. Label the can with the corresponding lot and subplot numbers, producer, producer facility location, grade, district, date sampled, and project information including highway and CSJ. The Engineer will retain these samples for one year. The Engineer may also obtain independent samples. If obtaining an independent asphalt binder sample and upon request of the Contractor, the Engineer will split a sample of the asphalt binder with the Contractor.
- At least once per project, the Engineer will collect split samples of each binder grade and source used. The Engineer will submit one split sample to MTD to verify compliance with Item 300, "Asphalts, Oils, and Emulsions" and will retain the other split sample for one year.
- 4.9.2.3. **Production Testing.** The Contractor and Engineer must perform production tests in accordance with Table 17. The Contractor has the option to verify the Engineer's test results on split samples provided by the Engineer. Determine compliance with operational tolerances listed in Table 12 for all sublots.

Take immediate corrective action if the Engineer's laboratory-molded density on any subplot is less than 95.0% or greater than 97.0% to bring the mixture within these tolerances. The Engineer may suspend operations if the Contractor's corrective actions do not produce acceptable results. The Engineer will allow production to resume when the proposed corrective action is likely to yield acceptable results.

The Engineer may allow alternate methods for determining the asphalt binder content and aggregate gradation if the aggregate mineralogy is such that [Tex-236-F](#), Part I does not yield reliable results. Provide evidence that results from [Tex-236-F](#), Part I are not reliable before requesting permission to use an alternate method unless otherwise directed. Use the applicable test procedure as directed if an alternate test method is allowed.

Table 17
Production and Placement Testing Frequency

Description	Test Method	Minimum Contractor Testing Frequency	Minimum Engineer Testing Frequency
Individual % retained for #8 sieve and larger	Tex-200-F or Tex-236-F	1 per subplot	1 per 12 sublots ¹
Individual % retained for sieves smaller than #8 and larger than #200			
% passing the #200 sieve			
Laboratory-molded density	Tex-207-F	N/A	1 per subplot ¹
Laboratory-molded bulk specific gravity			
In-place air voids			
VMA	Tex-204-F	1 per subplot ²	1 per project
Segregation (density profile)	Tex-207-F , Part V		
Longitudinal joint density	Tex-207-F , Part VII		
Moisture content	Tex-212-F , Part II	When directed	
Theoretical maximum specific (Rice) gravity	Tex-227-F	N/A	1 per subplot ¹
Asphalt binder content	Tex-236-F	1 per subplot	1 per lot ¹
Hamburg Wheel test	Tex-242-F	N/A	1 per project
Recycled Asphalt Shingles (RAS) ³	Tex-217-F , Part III	N/A	
Thermal profile	Tex-244-F	1 per subplot ²	
Asphalt binder sampling and testing	Tex-500-C , Part II	1 per lot (sample only) ⁴	
Tack coat sampling and testing	Tex-500-C , Part III	N/A	
Boil test ⁵	Tex-530-C	1 per lot	
Shear Bond Strength Test ⁶	Tex-249-F	1 per project (sample only)	

- For production defined in Section 3077.4.9.4., "Exempt Production," the Engineer will test one per day if 100 tons or more are produced. For Exempt Production, no testing is required when less than 100 tons are produced.
- To be performed in the presence of the Engineer, unless otherwise approved. Not required when a thermal imaging system is used.
- Testing performed by the Materials and Tests Division or designated laboratory.
- Obtain samples witnessed by the Engineer. The Engineer will retain these samples for one year.
- The Engineer may reduce or waive the sampling and testing requirements based on a satisfactory test history.
- Testing performed by the Materials and Tests Division or District for informational purposes only.

4.9.2.4. **Operational Tolerances.** Control the production process within the operational tolerances listed in Table 12. When production is suspended, the Engineer will allow production to resume when test results or other information indicates the next mixture produced will be within the operational tolerances.

4.9.2.4.1. **Gradation.** Suspend operation and take corrective action if any aggregate is retained on the maximum sieve size shown in Table 8. A subplot is defined as out of tolerance if either the Engineer's or the Contractor's test results are out of operational tolerance. Suspend production when test results for gradation exceed the operational tolerances in Table 12 for three consecutive sublots on the same sieve or four consecutive sublots on any sieve unless otherwise directed. The consecutive sublots may be from more than one lot.

4.9.2.4.2. **Asphalt Binder Content.** A subplot is defined as out of operational tolerance if either the Engineer's or the Contractor's test results exceed the values listed in Table 12. No production or placement payment

adjustments greater than 1.000 will be paid for any subplot that is out of operational tolerance for asphalt binder content. Suspend production and shipment of the mixture if the Engineer's or the Contractor's asphalt binder content deviates from the current JMF by more than 0.5% for any subplot.

- 4.9.2.4.3. **Voids in Mineral Aggregates (VMA).** The Engineer will determine the VMA for every subplot. For sublots when the Engineer does not determine asphalt binder content, the Engineer will use the asphalt binder content results from QC testing performed by the Contractor to determine VMA.

Take immediate corrective action if the VMA value for any subplot is less than the minimum VMA requirement for production listed in Table 8. Suspend production and shipment of the mixture if the Engineer's VMA results on two consecutive sublots are below the minimum VMA requirement for production listed in Table 8. No production or placement payment adjustments greater than 1.000 will be paid for any subplot that does not meet the minimum VMA requirement for production listed in Table 8 based on the Engineer's VMA determination.

Suspend production and shipment of the mixture if the Engineer's VMA result is more than 0.5% below the minimum VMA requirement for production listed in Table 8. In addition to suspending production, the Engineer may require removal and replacement or may allow the subplot to be left in place without payment.

- 4.9.2.4.4. **Hamburg Wheel Test.** The Engineer may perform a Hamburg Wheel test at any time during production, including when the boil test indicates a change in quality from the materials submitted for JMF 1. In addition to testing production samples, the Engineer may obtain cores and perform Hamburg Wheel tests on any areas of the roadway where rutting is observed. Suspend production until further Hamburg Wheel tests meet the specified values when the production or core samples fail the Hamburg Wheel test criteria in Table 11. Core samples, if taken, will be obtained from the center of the finished mat or other areas excluding the vehicle wheel paths. The Engineer may require up to the entire subplot of any mixture failing the Hamburg Wheel test to be removed and replaced at the Contractor's expense.

If the Department's or Department approved laboratory's Hamburg Wheel test results in a "remove and replace" condition, the Contractor may request that the Department confirm the results by re-testing the failing material. The Materials and Tests Division will perform the Hamburg Wheel tests and determine the final disposition of the material in question based on the Department's test results.

- 4.9.2.5. **Individual Loads of Hot-Mix.** The Engineer can reject individual truckloads of hot-mix. When a load of hot-mix is rejected for reasons other than temperature, contamination, or excessive uncoated particles, the Contractor may request that the rejected load be tested. Make this request within 4 hr. of rejection. The Engineer will sample and test the mixture. If test results are within the operational tolerances shown in Table 12, payment will be made for the load. If test results are not within operational tolerances, no payment will be made for the load.

4.9.3. **Placement Acceptance.**

- 4.9.3.1. **Placement Lot.** A placement lot consists of four placement sublots. A placement subplot consists of the area placed during a production subplot.

- 4.9.3.1.1. **Lot 1 Placement.** Placement payment adjustments greater than 1.000 for Lot 1 will be in accordance with Section 3077.6.2., "Placement Payment Adjustment Factors;" however, no placement adjustment less than 1.000 will be assessed for any subplot placed in Lot 1 when the in-place air voids are greater than or equal to 2.7% and less than or equal to 9.0%. Remove and replace any subplot with in-place air voids less than 2.7% or greater than 9.0%.

- 4.9.3.1.2. **Incomplete Placement Lots.** An incomplete placement lot consists of the area placed as described in Section 3077.4.9.2.1.1., "Incomplete Production Lot," excluding areas defined in Section 3077.4.9.3.1.4., "Miscellaneous Areas." Placement sampling is required if the random sample plan for production resulted in a sample being obtained from an incomplete production subplot.

- 4.9.3.1.3. **Shoulders, Ramps, Etc.** Shoulders, ramps, intersections, acceleration lanes, deceleration lanes, and turn lanes are subject to in-place air void determination and payment adjustments unless designated on the plans as not eligible for in-place air void determination. Intersections may be considered miscellaneous areas when determined by the Engineer.
- 4.9.3.1.4. **Miscellaneous Areas.** Miscellaneous areas include areas that typically involve significant handwork or discontinuous paving operations, such as temporary detours, driveways, mailbox turnouts, crossovers, gores, spot level-up areas, and other similar areas. Temporary detours are subject to in-place air void determination when shown on the plans. Miscellaneous areas also include level-ups and thin overlays when the layer thickness specified on the plans is less than the minimum untrimmed core height eligible for testing shown in Table 14. The specified layer thickness is based on the rate of 110 lb./sq. yd. for each inch of pavement unless another rate is shown on the plans. When "level up" is listed as part of the item bid description code, a payment adjustment factor of 1.000 will be assigned for all placement sublots as described in Article 3077.6, "Payment." Miscellaneous areas are not eligible for random placement sampling locations. Compact miscellaneous areas in accordance with Section 3077.4.8., "Compaction." Miscellaneous areas are not subject to in-place air void determination, thermal profiles testing, segregation (density profiles), or longitudinal joint density evaluations.
- 4.9.3.2. **Placement Sampling.** The Engineer will select random numbers for all placement sublots at the beginning of the project. The Engineer will provide the Contractor with the placement random numbers immediately after the subplot is completed. Mark the roadway location at the completion of each subplot and record the station number. Determine one random sample location for each placement subplot in accordance with [Tex-225-F](#). Adjust the random sample location by no more than necessary to achieve a 2-ft. clearance if the location is within 2 ft. of a joint or pavement edge.

Shoulders, ramps, intersections, acceleration lanes, deceleration lanes, and turn lanes are always eligible for selection as a random sample location; however, if a random sample location falls on one of these areas and the area is designated on the plans as not subject to in-place air void determination, cores will not be taken for the subplot and a 1.000 pay factor will be assigned to that subplot.

Provide the equipment and means to obtain and trim roadway cores on-site. On-site is defined as in close proximity to where the cores are taken. Obtain the cores within one working day of the time the placement subplot is completed unless otherwise approved. Obtain two 6-in. diameter cores side-by-side from within 1 ft. of the random location provided for the placement subplot. For SP-C and SP-D mixtures, 4-in. diameter cores are allowed. Mark the cores for identification, measure and record the untrimmed core height, and provide the information to the Engineer. The Engineer will witness the coring operation and measurement of the core thickness. Visually inspect each core and verify that the current paving layer is bonded to the underlying layer. Take corrective action if an adequate bond does not exist between the current and underlying layer to ensure that an adequate bond will be achieved during subsequent placement operations.

Trim the cores immediately after obtaining the cores from the roadway in accordance with [Tex-251-F](#) if the core heights meet the minimum untrimmed value listed in Table 14. Trim the cores on-site in the presence of the Engineer. Use a permanent marker or paint pen to record the lot and subplot numbers on each core as well as the designation as Core A or B. The Engineer may require additional information to be marked on the core and may choose to sign or initial the core. The Engineer will take custody of the cores immediately after witnessing the trimming of the cores and will retain custody of the cores until the Department's testing is completed. Before turning the trimmed cores over to the Engineer, the Contractor may wrap the trimmed cores or secure them in a manner that will reduce the risk of possible damage occurring during transport by the Engineer. After testing, the Engineer will return the cores to the Contractor.

The Engineer may have the cores transported back to the Department's laboratory at the HMA plant via the Contractor's haul truck or other designated vehicle. In such cases where the cores will be out of the Engineer's possession during transport, the Engineer will use Department-provided security bags and the Roadway Core Custody protocol located at <http://www.txdot.gov/business/specifications.htm> to provide a secure means and process that protects the integrity of the cores during transport.

Decide whether to include the pair of cores in the air void determination for that subplot if the core height before trimming is less than the minimum untrimmed value shown in Table 14. Trim the cores as described above before delivering to the Engineer if electing to have the cores included in the air void determination. Deliver untrimmed cores to the Engineer and inform the Engineer of the decision to not have the cores included in air void determination if electing to not have the cores included in air void determination. The placement pay factor for the subplot will be 1.000 if cores will not be included in air void determination.

Instead of the Contractor trimming the cores on-site immediately after coring, the Engineer and the Contractor may mutually agree to have the trimming operations performed at an alternate location such as a field laboratory or other similar location. In such cases, the Engineer will take possession of the cores immediately after they are obtained from the roadway and will retain custody of the cores until testing is completed. Either the Department or Contractor representative may perform trimming of the cores. The Engineer will witness all trimming operations in cases where the Contractor representative performs the trimming operation.

Dry the core holes and tack the sides and bottom immediately after obtaining the cores. Fill the hole with the same type of mixture and properly compact the mixture. Repair core holes with other methods when approved.

4.9.3.3. **Placement Testing.** Perform placement tests in accordance with Table 17. After the Engineer returns the cores, the Contractor may test the cores to verify the Engineer's test results for in-place air voids. The allowable differences between the Contractor's and Engineer's test results are listed in Table 12.

4.9.3.3.1. **In-Place Air Voids.** The Engineer will measure in-place air voids in accordance with [Tex-207-F](#) and [Tex-227-F](#). Before drying to a constant weight, cores may be pre-dried using a CoreDry or similar vacuum device to remove excess moisture. The Engineer will average the values obtained for all sublots in the production lot to determine the theoretical maximum specific gravity. The Engineer will use the average air void content for in-place air voids.

The Engineer will use the vacuum method to seal the core if required by [Tex-207-F](#). The Engineer will use the test results from the unsealed core to determine the placement payment adjustment factor if the sealed core yields a higher specific gravity than the unsealed core. After determining the in-place air void content, the Engineer will return the cores and provide test results to the Contractor.

4.9.3.3.2. **Segregation (Density Profile).** Test for segregation using density profiles in accordance with [Tex-207-F](#), Part V when using a thermal camera instead of the thermal imaging system. Density profiles are not required and are not applicable when using a thermal imaging system. Density profiles are not applicable in areas described in Section 3077.4.9.3.1.4., "Miscellaneous Areas."

Perform a minimum of one density profile per subplot. Perform additional density profiles when any of the following conditions occur, unless otherwise approved:

- the paver stops due to lack of material being delivered to the paving operations and the temperature of the uncompacted mat before the initial break down rolling is less than the temperatures shown in Table 18;
- areas that are identified by either the Contractor or the Engineer with thermal segregation;
- any visibly segregated areas that exist.

Table 18
Minimum Uncompacted Mat Temperature Requiring a Segregation Profile

High-Temperature Binder Grade¹	Minimum Temperature of the Uncompacted Mat Allowed Before Initial Break Down Rolling^{2,3,4}
PG 64	<250°F
PG 70	<260°F
PG 76	<270°F

1. The high-temperature binder grade refers to the high-temperature grade of the virgin asphalt binder used to produce the mixture.
2. Segregation profiles are required in areas with moderate and severe thermal segregation as described in Section 3077.4.7.3.1.3.
3. Minimum uncompacted mat temperature requiring a segregation profile may be reduced 10°F if using a chemical WMA additive as a compaction aid.
4. When using WMA, the minimum uncompacted mat temperature requiring a segregation profile is 215°F.

Provide the Engineer with the density profile of every subplot in the lot within one working day of the completion of each lot. Report the results of each density profile in accordance with Section 3077.4.2., "Reporting and Responsibilities."

The density profile is considered failing if it exceeds the tolerances in Table 19. No production or placement payment adjustments greater than 1.000 will be paid for any subplot that contains a failing density profile. When a hand-held thermal camera is used instead of a thermal imaging system, the Engineer will measure the density profile at least once per project. The Engineer's density profile results will be used when available. The Engineer may require the Contractor to remove and replace the area in question if the area fails the density profile and has surface irregularities as defined in Section 3077.4.9.3.3.5., "Irregularities." The subplot in question may receive a production and placement payment adjustment greater than 1.000, if applicable, when the defective material is successfully removed and replaced.

Investigate density profile failures and take corrective actions during production and placement to eliminate the segregation. Suspend production if two consecutive density profiles fail unless otherwise approved. Resume production after the Engineer approves changes to production or placement methods.

Table 19
Segregation (Density Profile) Acceptance Criteria

Mixture Type	Maximum Allowable Density Range (Highest to Lowest)	Maximum Allowable Density Range (Average to Lowest)
SP-B	8.0 pcf	5.0 pcf
SP-C & SP-D	6.0 pcf	3.0 pcf

4.9.3.3.3. Longitudinal Joint Density.

4.9.3.3.3.1. **Informational Tests.** Perform joint density evaluations while establishing the rolling pattern and verify that the joint density is no more than 3.0 pcf below the density taken at or near the center of the mat. Adjust the rolling pattern, if needed, to achieve the desired joint density. Perform additional joint density evaluations at least once per subplot unless otherwise directed.

4.9.3.3.3.2. **Record Tests.** Perform a joint density evaluation for each subplot at each pavement edge that is or will become a longitudinal joint. Joint density evaluations are not applicable in areas described in Section 3077.4.9.3.1.4., "Miscellaneous Areas." Determine the joint density in accordance with [Tex-207-F](#), Part VII. Record the joint density information and submit results on Department forms to the Engineer. The evaluation is considered failing if the joint density is more than 3.0 pcf below the density taken at the core random sample location and the correlated joint density is less than 90.0%. The Engineer will make independent joint density verification at least once per project and may make independent joint density

verifications at the random sample locations. The Engineer's joint density test results will be used when available.

Provide the Engineer with the joint density of every subplot in the lot within one working day of the completion of each lot. Report the results of each joint density in accordance with Section 3077.4.2., "Reporting and Responsibilities."

Investigate joint density failures and take corrective actions during production and placement to improve the joint density. Suspend production if the evaluations on two consecutive sublots fail unless otherwise approved. Resume production after the Engineer approves changes to production or placement methods.

4.9.3.3.4. **Recovered Asphalt Dynamic Shear Rheometer (DSR).** The Engineer may take production samples or cores from suspect areas of the project to determine recovered asphalt properties. Asphalt binders with an aging ratio greater than 3.5 do not meet the requirements for recovered asphalt properties and may be deemed defective when tested and evaluated by the Materials and Tests Division. The aging ratio is the DSR value of the extracted binder divided by the DSR value of the original unaged binder. Obtain DSR values in accordance with AASHTO T 315 at the specified high temperature performance grade of the asphalt. The Engineer may require removal and replacement of the defective material at the Contractor's expense. The asphalt binder will be recovered for testing from production samples or cores in accordance with [Tex-211-F](#).

4.9.3.3.5. **Irregularities.** Identify and correct irregularities including segregation, rutting, raveling, flushing, fat spots, mat slippage, irregular color, irregular texture, roller marks, tears, gouges, streaks, uncoated aggregate particles, or broken aggregate particles. The Engineer may also identify irregularities, and in such cases, the Engineer will promptly notify the Contractor. If the Engineer determines that the irregularity will adversely affect pavement performance, the Engineer may require the Contractor to remove and replace (at the Contractor's expense) areas of the pavement that contain irregularities. The Engineer may also require the Contractor to remove and replace (at the Contractor's expense) areas where the mixture does not bond to the existing pavement.

If irregularities are detected, the Engineer may require the Contractor to immediately suspend operations or may allow the Contractor to continue operations for no more than one day while the Contractor is taking appropriate corrective action.

4.9.4. **Exempt Production.** The Engineer may deem the mixture as exempt production for the following conditions:

- anticipated daily production is less than 500 tons;
- total production for the project is less than 5,000 tons;
- when mutually agreed between the Engineer and the Contractor; or
- when shown on the plans.

For exempt production, the Contractor is relieved of all production and placement QC/QA sampling and testing requirements, except for coring operations when required by the Engineer. The production and placement pay factors are 1.000 if the specification requirements listed below are met, all other specification requirements are met, and the Engineer performs acceptance tests for production and placement listed in Table 17 when 100 tons or more per day are produced:

- produce, haul, place, and compact the mixture in compliance with the specification and as directed;
- control mixture production to yield a laboratory-molded density that is within $\pm 1.0\%$ of the target laboratory-molded density as tested by the Engineer;
- compact the mixture in accordance with Section 3077.4.8., "Compaction"; and
- when a thermal imaging system is not used, the Engineer may perform segregation (density profiles) and thermal profiles in accordance with the specification.

4.9.5. **Ride Quality.** Measure ride quality in accordance with Item 585, "Ride Quality for Pavement Surfaces," unless otherwise shown on the plans.

5. MEASUREMENT

- 5.1. **Superpave Mixtures.** Hot mix will be measured by the ton of composite hot-mix, which includes asphalt, aggregate, and additives. Measure the weight on scales in accordance with Item 520, "Weighing and Measuring Equipment."
- 5.2. **Tack Coat.** Tack coat will be measured at the applied temperature by strapping the tank before and after road application and determining the net volume in gallons from the calibrated distributor. The Engineer will witness all strapping operations for volume determination. All tack, including emulsions, will be measure by the gallon applied.

The Engineer may allow the use of a metering device to determine the asphalt volume used and application rate if the device is accurate within 1.5% of the strapped volume.

6. PAYMENT

The work performed and materials furnished in accordance with this Item and measured as provided under Article 3077.5.1, "Measurement," will be paid for at the unit bid price for "Superpave Mixtures" of the mixture type, SAC, and binder specified. These prices are full compensation for surface preparation, materials, placement, equipment, labor, tools, and incidentals.

The work performed and materials furnished in accordance with this Item and measured as provided under Article 3077.5.2, "Measurement," will be paid for at the unit bid price for "Tack Coat" of the tack coat provided. These prices are full compensation for materials, placement, equipment, labor, tools, and incidentals. Payment adjustments will be applied as determined in this Item; however, a payment adjustment factor of 1.000 will be assigned for all placement sublots for "level ups" only when "level up" is listed as part of the item bid description code. A payment adjustment factor of 1.000 will be assigned to all production and placement sublots when "exempt" is listed as part of the item bid description code, and all testing requirements are met.

Payment for each subplot, including applicable payment adjustments greater than 1.000, will only be paid for sublots when the Contractor supplies the Engineer with the required documentation for production and placement QC/QA, thermal profiles, segregation density profiles, and longitudinal joint densities in accordance with Section 3077.4.2., "Reporting and Responsibilities." When a thermal imaging system is used, documentation is not required for thermal profiles or segregation density profiles on individual sublots; however, the thermal imaging system automated reports described in [Tex-244-F](#) are required.

Trial batches will not be paid for unless they are included in pavement work approved by the Department.

Payment adjustment for ride quality will be determined in accordance with Item 585, "Ride Quality for Pavement Surfaces."

- 6.1. **Production Payment Adjustment Factors.** The production payment adjustment factor is based on the laboratory-molded density using the Engineer's test results. The bulk specific gravities of the samples from each subplot will be divided by the Engineer's maximum theoretical specific gravity for the subplot. The individual sample densities for the subplot will be averaged to determine the production payment adjustment factor in accordance with Table 20 for each subplot using the deviation from the target laboratory-molded density defined in Table 10. The production payment adjustment factor for completed lots will be the average of the payment adjustment factors for the four sublots sampled within that lot.

Table 20
Production Payment Adjustment Factors for Laboratory-Molded Density¹

Absolute Deviation from Target Laboratory-Molded Density	Production Payment Adjustment Factor (Target Laboratory-Molded Density)
0.0	1.075
0.1	1.075
0.2	1.075
0.3	1.066
0.4	1.057
0.5	1.047
0.6	1.038
0.7	1.029
0.8	1.019
0.9	1.010
1.0	1.000
1.1	0.900
1.2	0.800
1.3	0.700
> 1.3	Remove and replace

1. If the Engineer's laboratory-molded density on any subplot is less than 95.0% or greater than 97.0%, take immediate corrective action to bring the mixture within these tolerances. The Engineer may suspend operations if the Contractor's corrective actions do not produce acceptable results. The Engineer will allow production to resume when the proposed corrective action is likely to yield acceptable results.

- 6.1.1. **Payment for Incomplete Production Lots.** Production payment adjustments for incomplete lots, described under Section 3077.4.9.2.1.1., "Incomplete Production Lots," will be calculated using the average production pay factors from all sublots sampled.

A production payment factor of 1.000 will be assigned to any lot when the random sampling plan did not result in collection of any samples within the first subplot.

- 6.1.2. **Production Sublots Subject to Removal and Replacement.** If after referee testing, the laboratory-molded density for any subplot results in a "remove and replace" condition as listed in Table 20, the Engineer may require removal and replacement or may allow the subplot to be left in place without payment. The Engineer may also accept the subplot in accordance with Section 3077.5.3.1., "Acceptance of Defective or Unauthorized Work." Replacement material meeting the requirements of this Item will be paid for in accordance with this Section.

- 6.2. **Placement Payment Adjustment Factors.** The placement payment adjustment factor is based on in-place air voids using the Engineer's test results. The bulk specific gravities of the cores from each subplot will be divided by the Engineer's average maximum theoretical specific gravity for the lot. The individual core densities for the subplot will be averaged to determine the placement payment adjustment factor in accordance with Table 21 for each subplot that requires in-place air void measurement. A placement payment adjustment factor of 1.000 will be assigned to the entire subplot when the random sample location falls in an area designated on the plans as not subject to in-place air void determination. A placement payment adjustment factor of 1.000 will be assigned to quantities placed in areas described in Section 3077.4.9.3.1.4., "Miscellaneous Areas." The placement payment adjustment factor for completed lots will be the average of the placement payment adjustment factors for up to four sublots within that lot.

Table 21
Placement Payment Adjustment Factors for In-Place Air Voids

In-Place Air Voids	Placement Payment Adjustment Factor	In-Place Air Voids	Placement Payment Adjustment Factor
< 2.7	Remove and Replace	5.9	1.048
2.7	0.710	6.0	1.045
2.8	0.740	6.1	1.042
2.9	0.770	6.2	1.039
3.0	0.800	6.3	1.036
3.1	0.830	6.4	1.033
3.2	0.860	6.5	1.030
3.3	0.890	6.6	1.027
3.4	0.920	6.7	1.024
3.5	0.950	6.8	1.021
3.6	0.980	6.9	1.018
3.7	1.000	7.0	1.015
3.8	1.015	7.1	1.012
3.9	1.030	7.2	1.009
4.0	1.045	7.3	1.006
4.1	1.060	7.4	1.003
4.2	1.075	7.5	1.000
4.3	1.075	7.6	0.980
4.4	1.075	7.7	0.960
4.5	1.075	7.8	0.940
4.6	1.075	7.9	0.920
4.7	1.075	8.0	0.900
4.8	1.075	8.1	0.880
4.9	1.075	8.2	0.860
5.0	1.075	8.3	0.840
5.1	1.072	8.4	0.820
5.2	1.069	8.5	0.800
5.3	1.066	8.6	0.780
5.4	1.063	8.7	0.760
5.5	1.060	8.8	0.740
5.6	1.057	8.9	0.720
5.7	1.054	9.0	0.700
5.8	1.051	> 9.0	Remove and Replace

- 6.2.1. **Payment for Incomplete Placement Lots.** Payment adjustments for incomplete placement lots described under Section 3077.4.9.3.1.2., "Incomplete Placement Lots," will be calculated using the average of the placement pay factors from all sublots sampled and sublots where the random location falls in an area designated on the plans as not eligible for in-place air void determination.

If the random sampling plan results in production samples, but not in placement samples, the random core location and placement adjustment factor for the subplot will be determined by applying the placement random number to the length of the subplot placed.

If the random sampling plan results in placement samples, but not in production samples, no placement adjustment factor will apply for that subplot placed.

A placement payment adjustment factor of 1.000 will be assigned to any lot when the random sampling plan did not result in collection of any production samples.

- 6.2.2. **Placement Sublots Subject to Removal and Replacement.** If after referee testing, the placement payment adjustment factor for any subplot results in a "remove and replace" condition as listed in Table 21, the Engineer will choose the location of two cores to be taken within 3 ft. of the original failing core location. The Contractor will obtain the cores in the presence of the Engineer. The Engineer will take immediate possession of the untrimmed cores and submit the untrimmed cores to the Materials and Tests Division,

where they will be trimmed, if necessary, and tested for bulk specific gravity within 10 working days of receipt.

The bulk specific gravity of the cores from each subplot will be divided by the Engineer's average maximum theoretical specific gravity for the lot. The individual core densities for the subplot will be averaged to determine the new payment adjustment factor of the subplot in question. If the new payment adjustment factor is 0.700 or greater, the new payment adjustment factor will apply to that subplot. If the new payment adjustment factor is less than 0.700, no payment will be made for the subplot. Remove and replace the failing subplot, or the Engineer may allow the subplot to be left in place without payment. The Engineer may also accept the subplot in accordance with Section 3077.5.3.1., "Acceptance of Defective or Unauthorized Work." Replacement material meeting the requirements of this Item will be paid for in accordance with this Section.

- 6.3. **Total Adjusted Pay Calculation.** Total adjusted pay (TAP) will be based on the applicable payment adjustment factors for production and placement for each lot.

$$TAP = (A+B)/2$$

where:

A = Bid price × production lot quantity × average payment adjustment factor for the production lot

B = Bid price × placement lot quantity × average payment adjustment factor for the placement lot + (bid price × quantity placed in miscellaneous areas × 1.000)

Production lot quantity = Quantity actually placed - quantity left in place without payment

Placement lot quantity = Quantity actually placed - quantity left in place without payment - quantity placed in miscellaneous areas



Level 1B Special Specification 3077 Exercise

1. When does the Engineer select random numbers for all placement sublots?
2. What Table gives the Reporting Schedule?
3. What is the maximum production temperature for a PG 70 binder?
4. Warm Mix Asphalt (WMA) is defined as HMA that is produced within a target temperature discharge range of what temperature?
5. What table do you find the test methods, test responsibility, and minimum certification levels?
6. What is the Engineers testing frequency for Longitudinal Joint Density?
7. What is the minimum thickness of an untrimmed core for a SP-D core?
8. When using a thermal imaging system during night paving, what is the minimum pavement surface temperature for a PG 70 binder?
9. What is the Contractor's testing frequency for Segregation Density Profile?
10. What are the three different mix types?